

別図

宝町・鶴間地区避難経路図

別図

医学類棟避難経路図

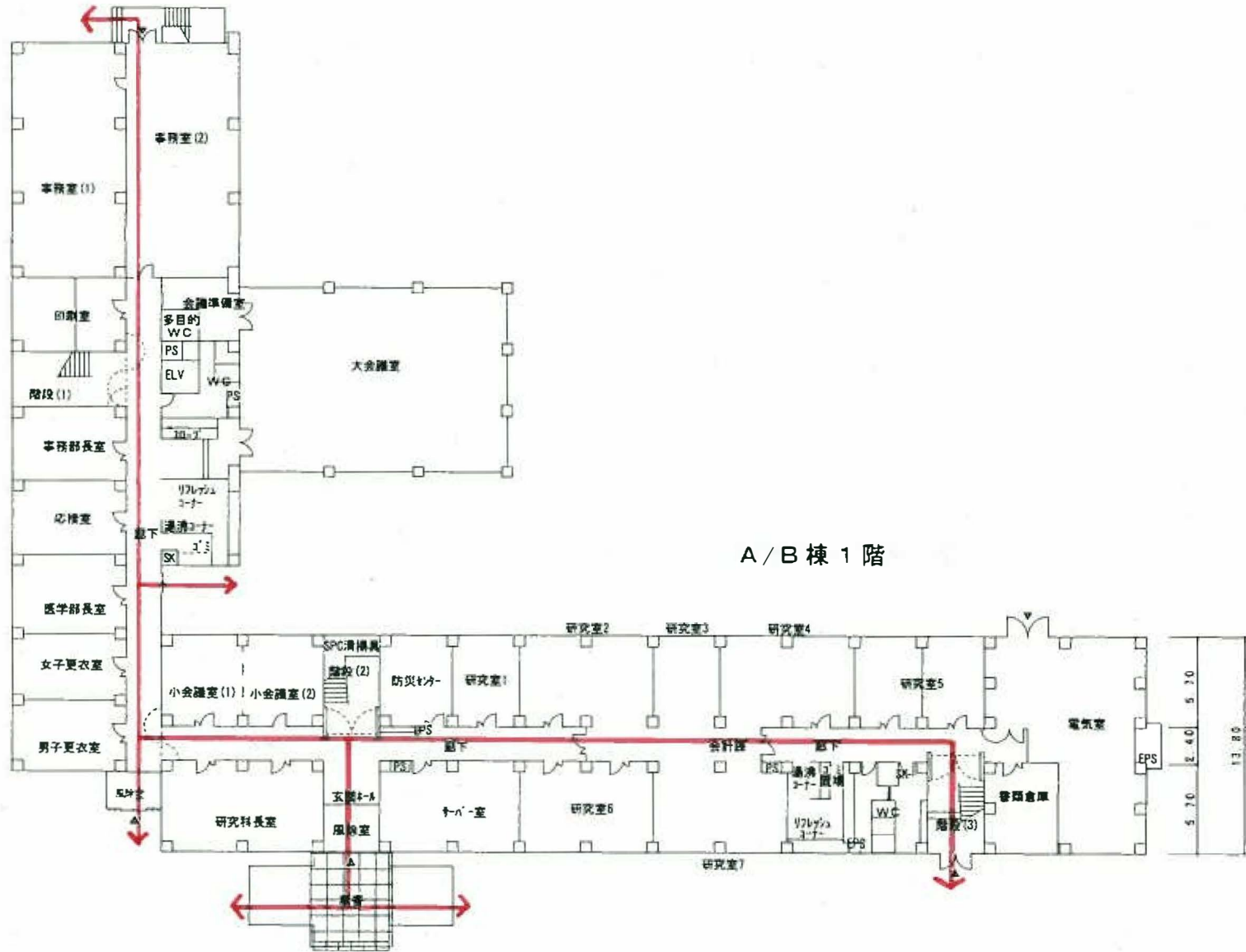

A/B棟 1階

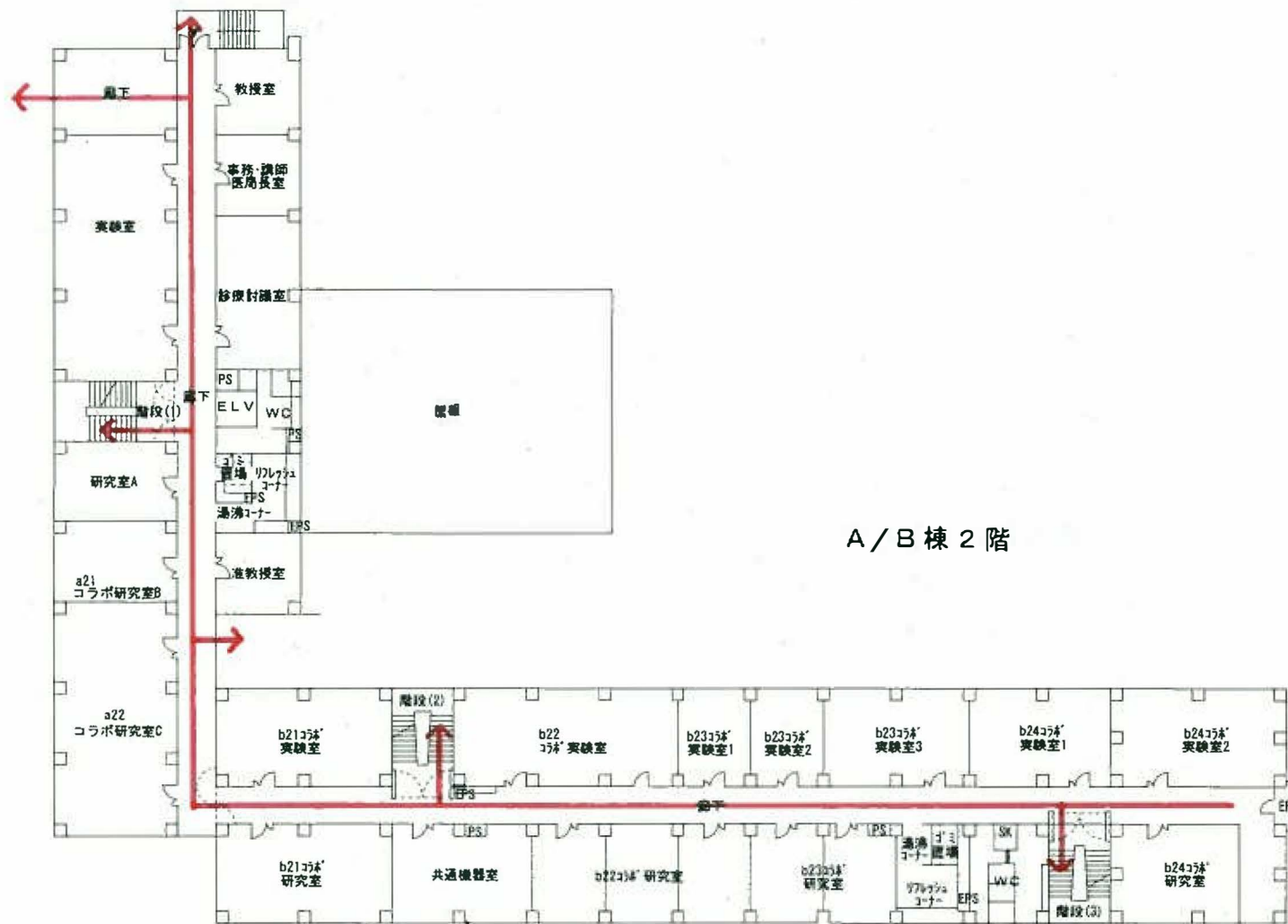

A/B棟 2階

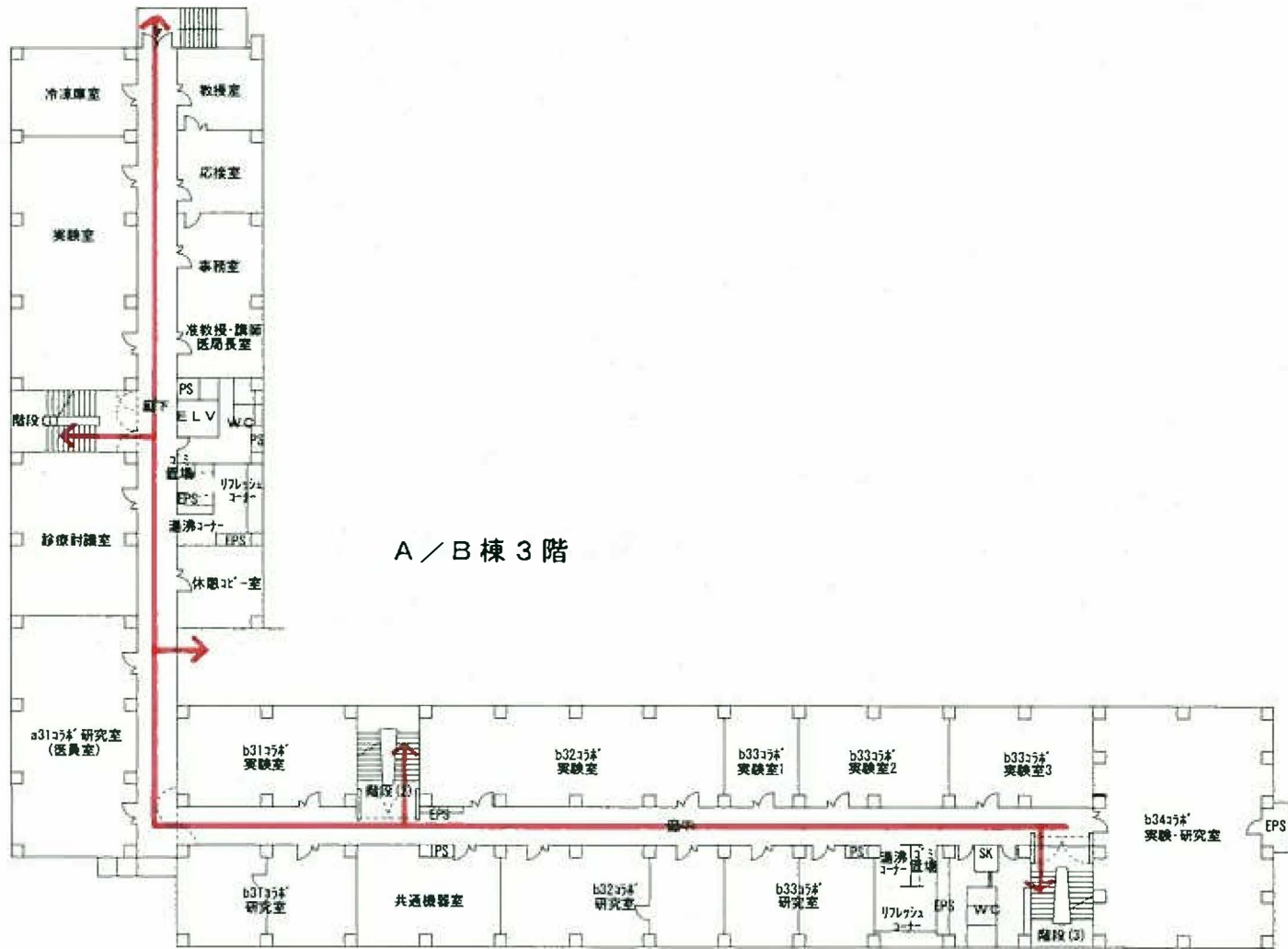

A / B 棟 3 階

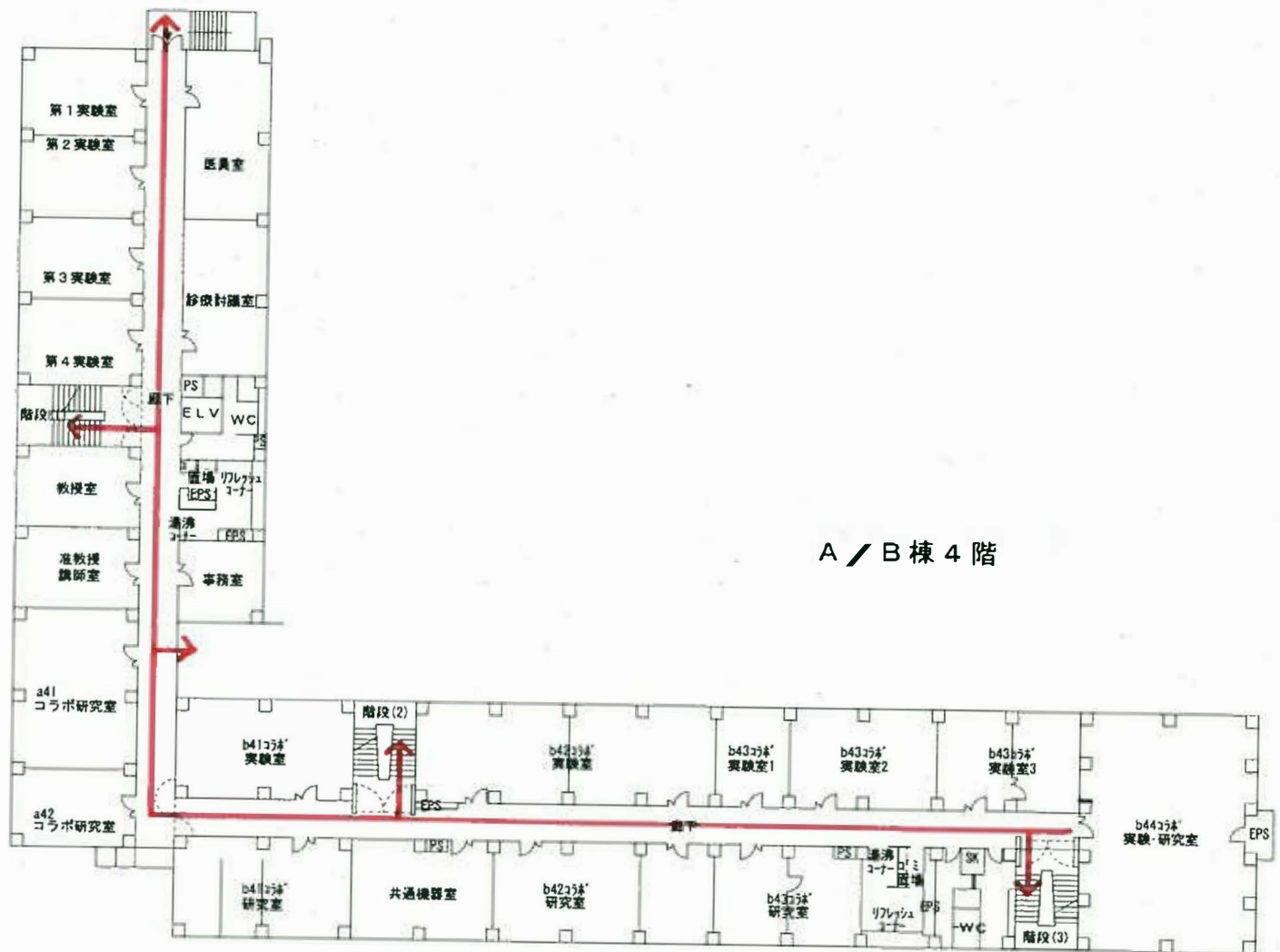

A / B 棟 4 階

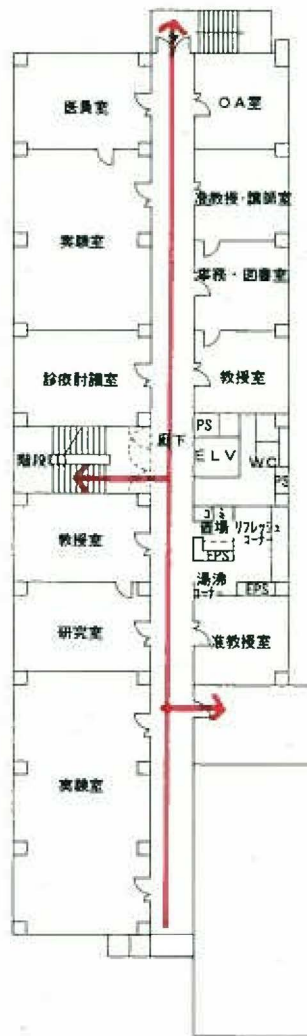

A / B 棟 5 階

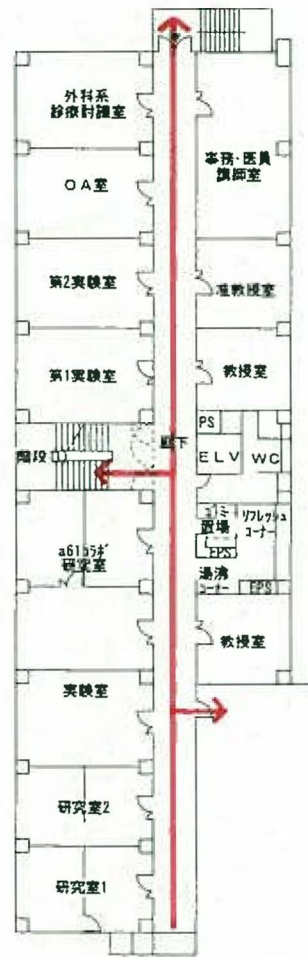

A棟6階

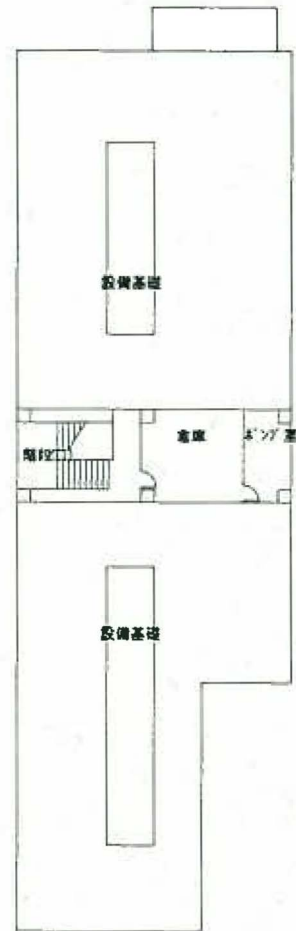

A棟屋階

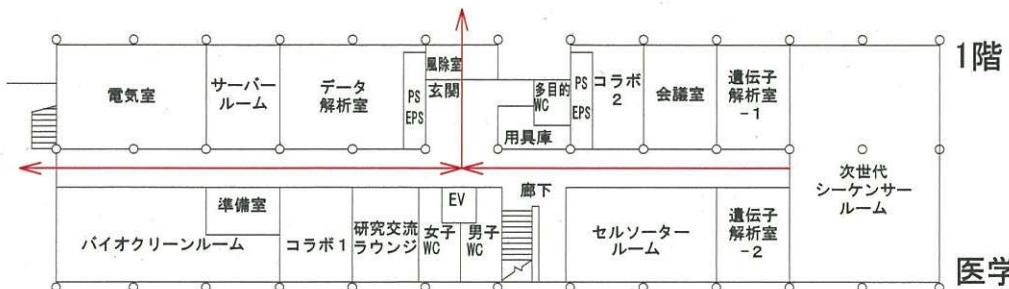
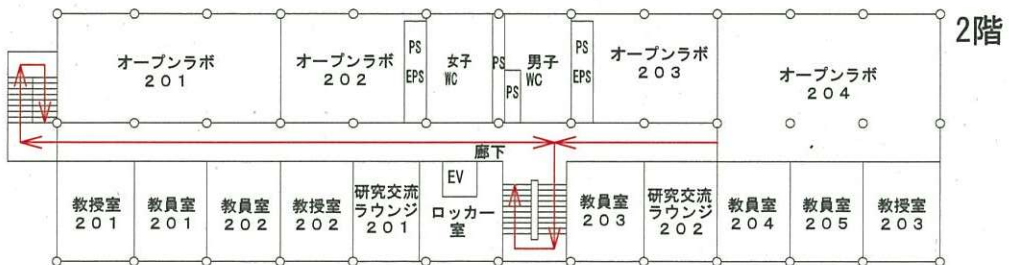
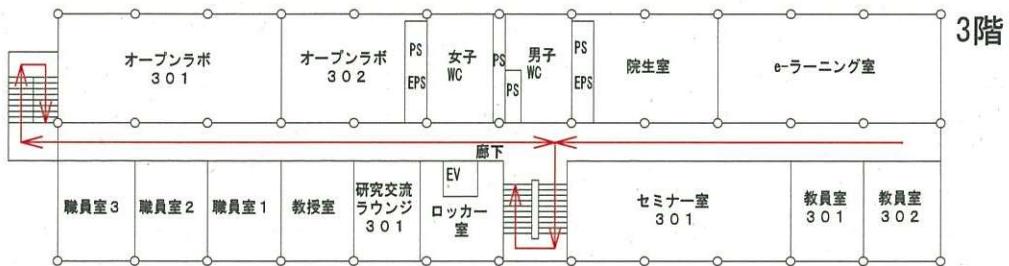
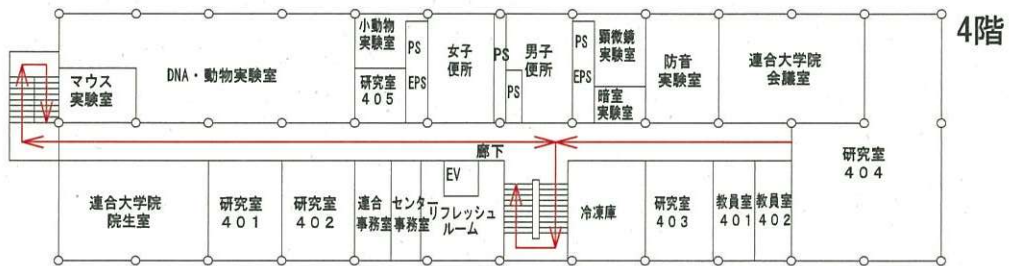
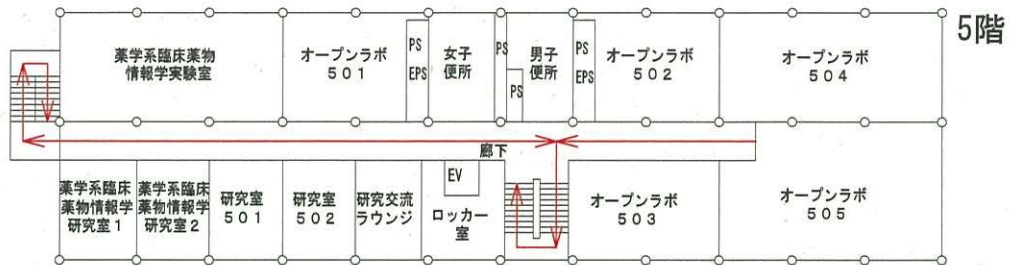
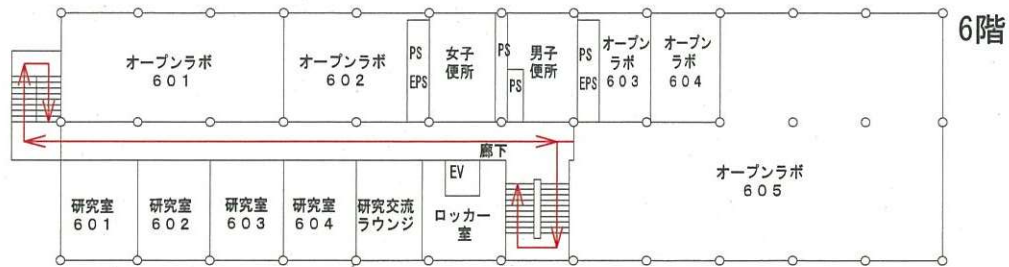

医学類D棟

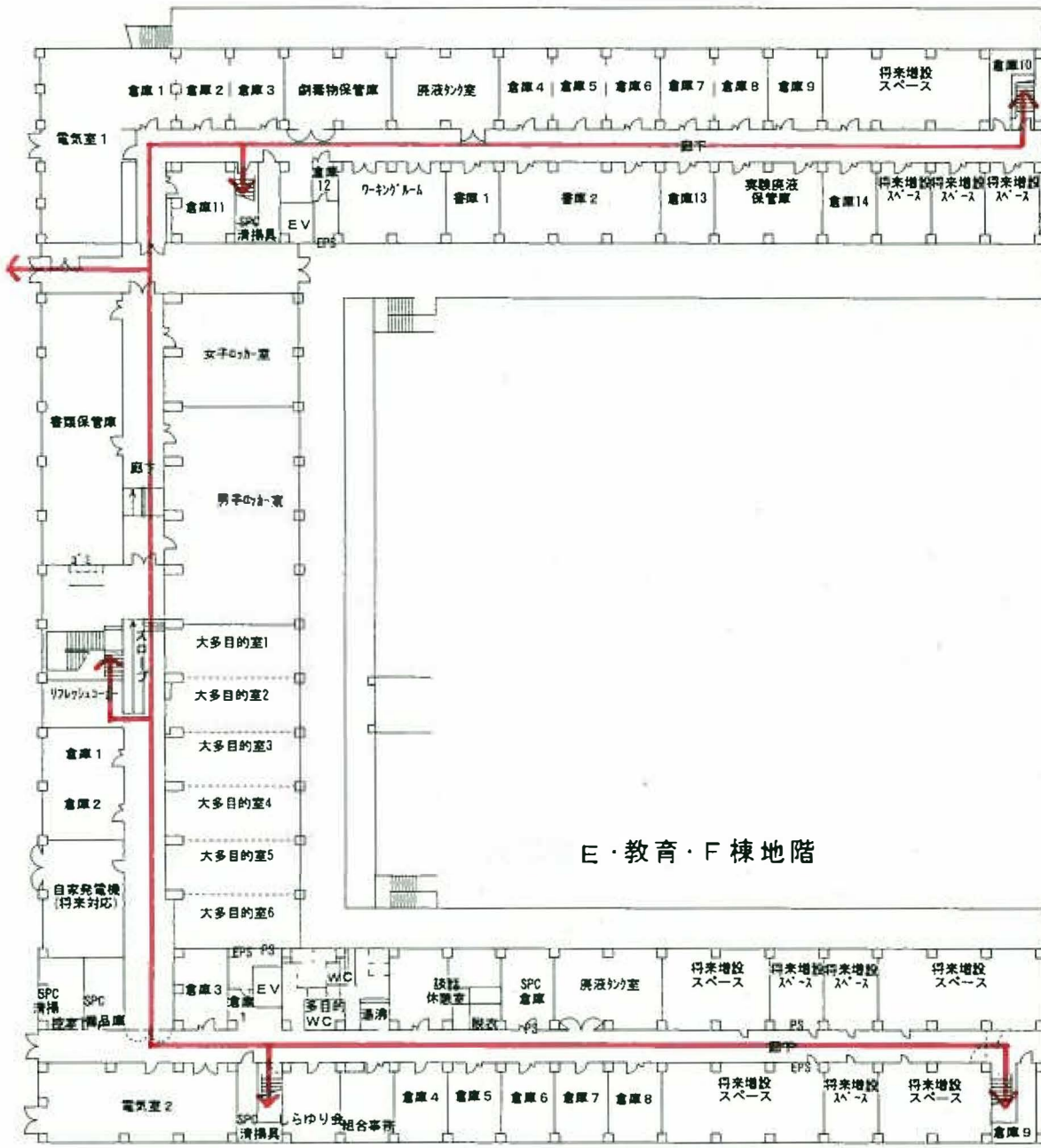

扉の下に
施設
している

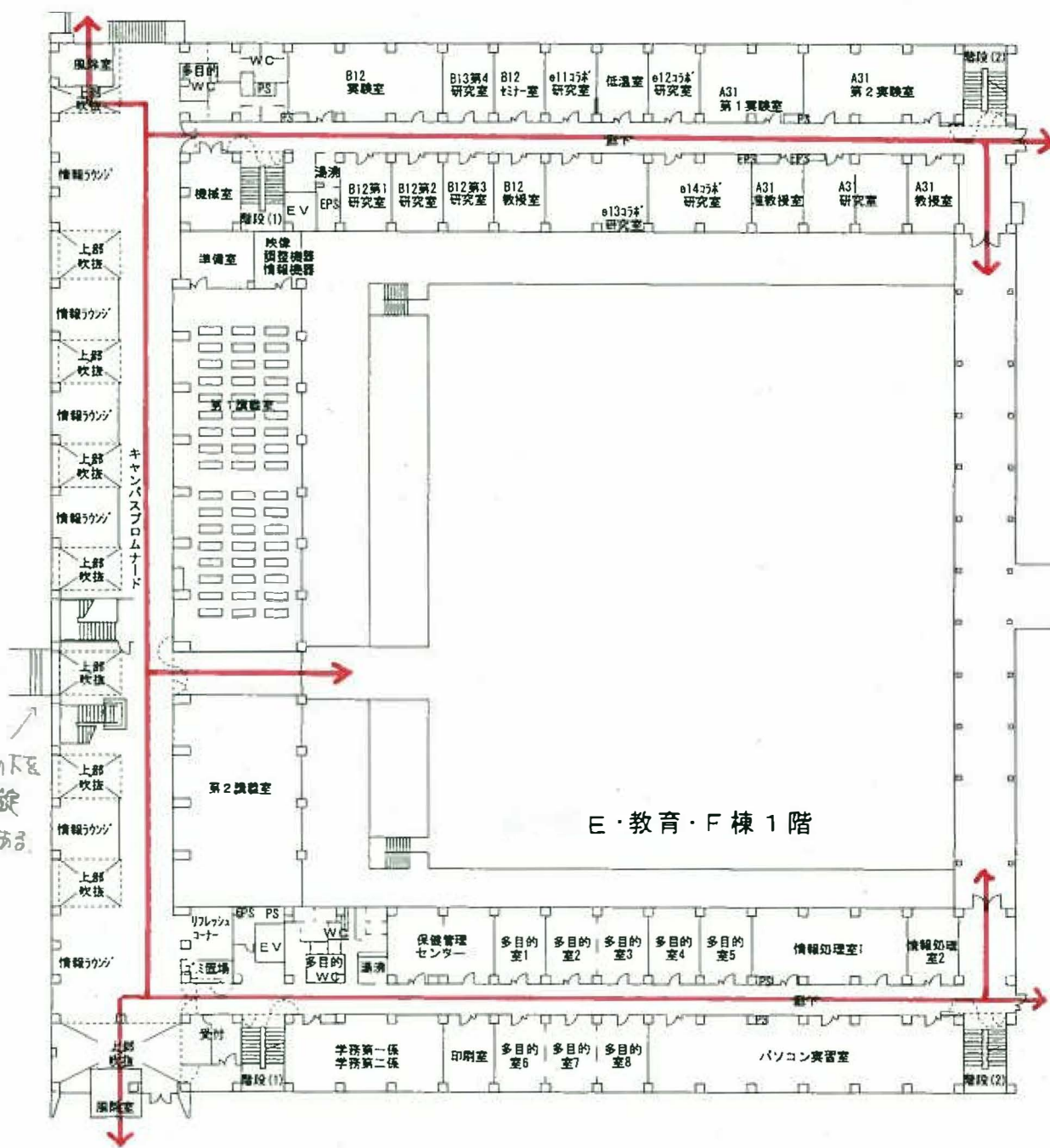

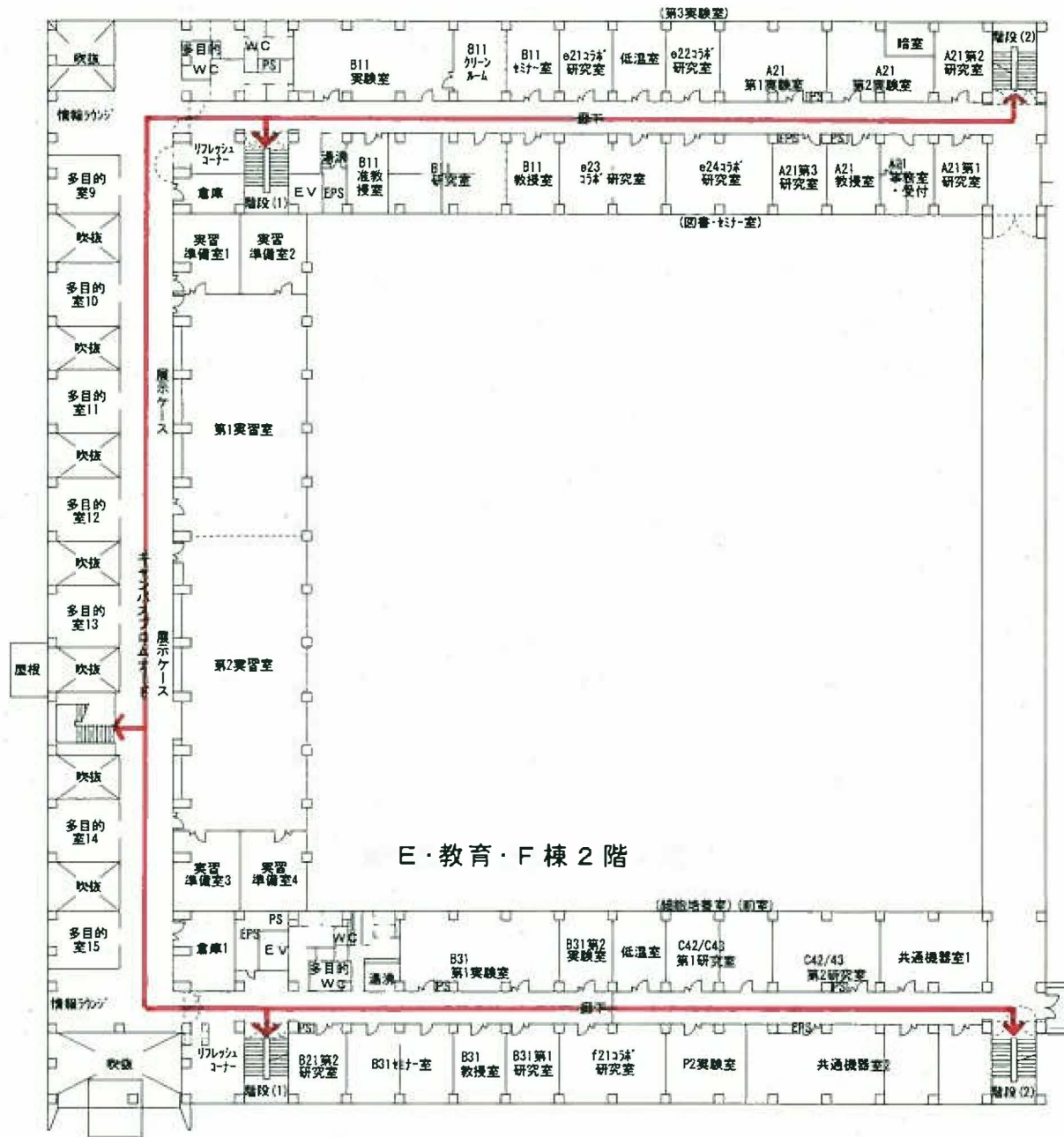

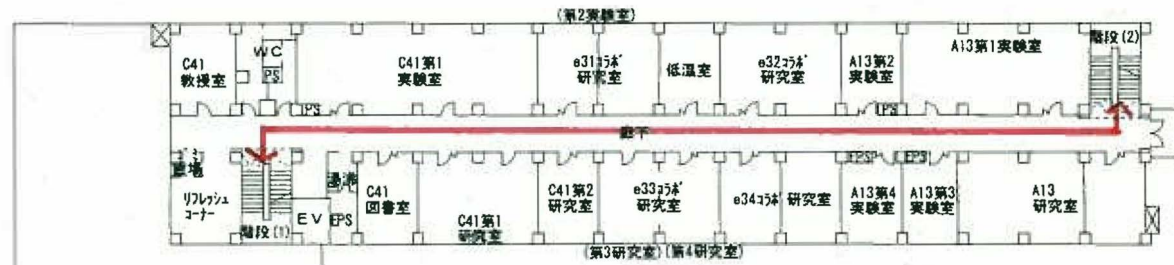

設備

E・教育・F棟3階

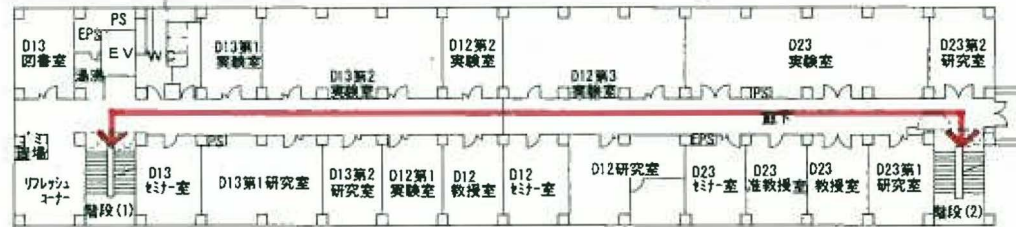

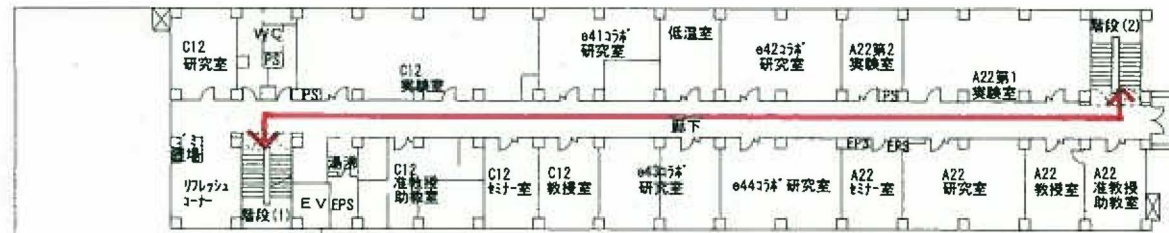

エレベーター

E・教育・F棟4階

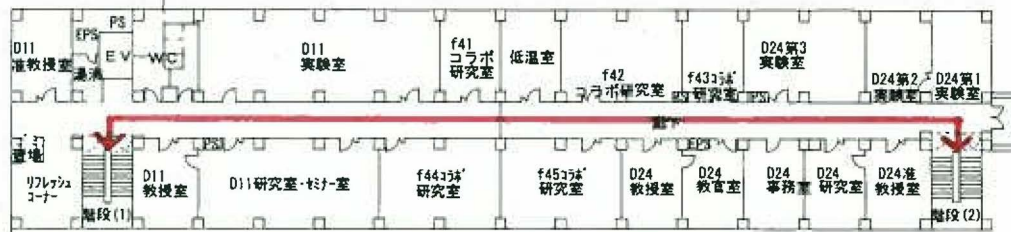

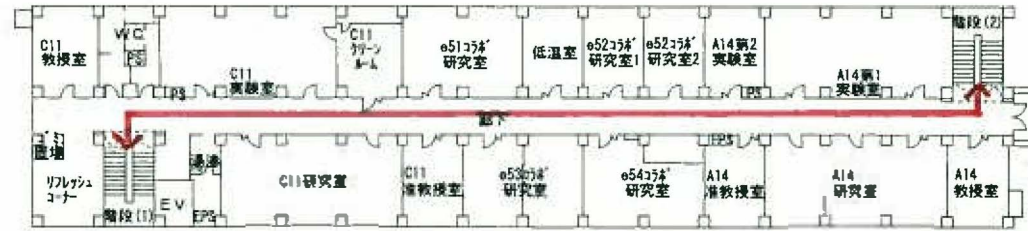

E・教育・F棟5階

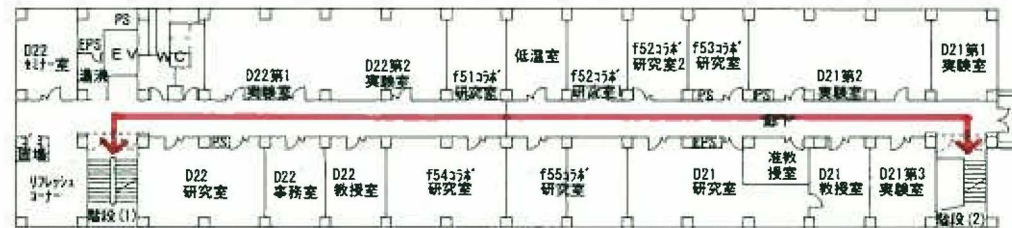

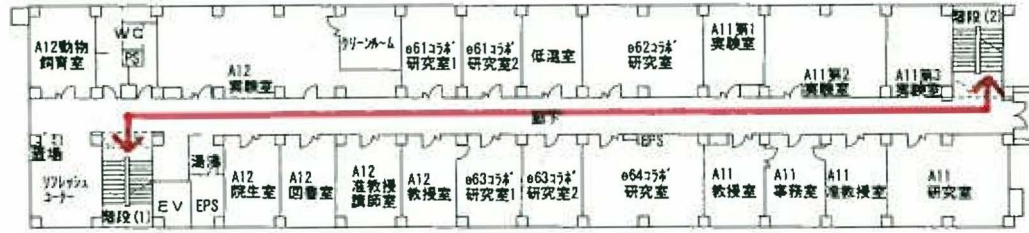

E棟6階

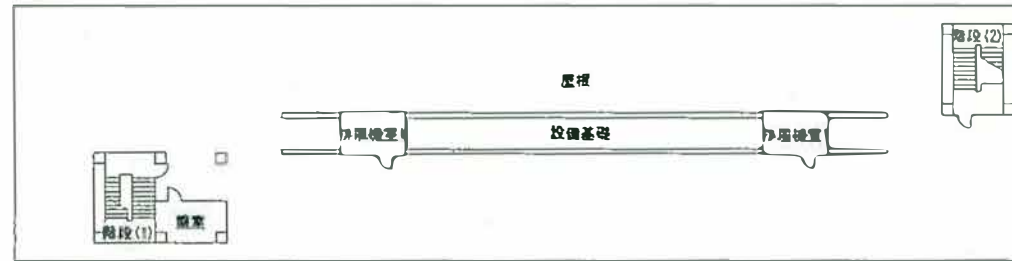

E棟屋階



F棟屋階

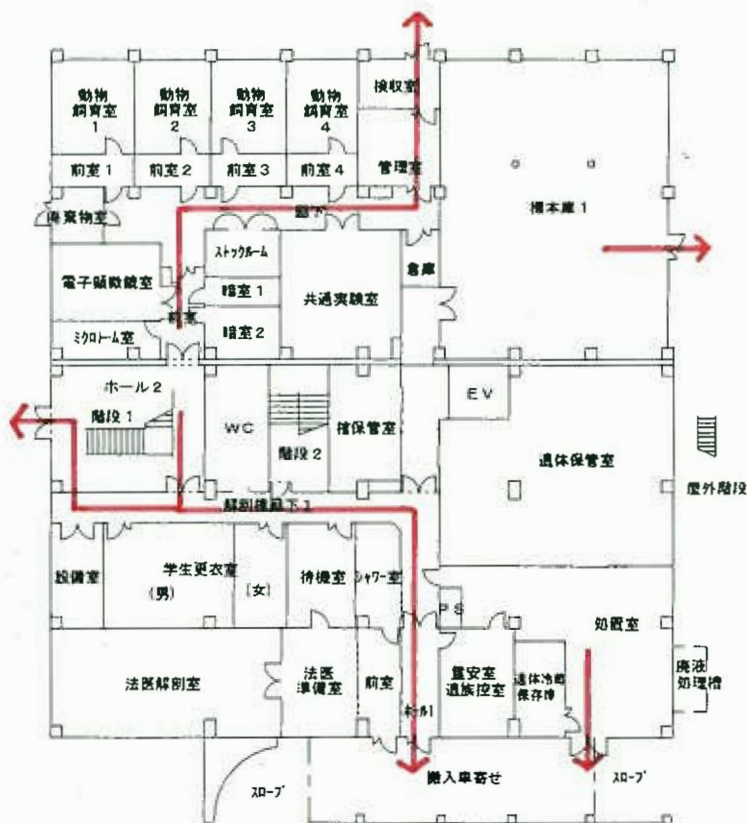

医学類 G 棟 1 階

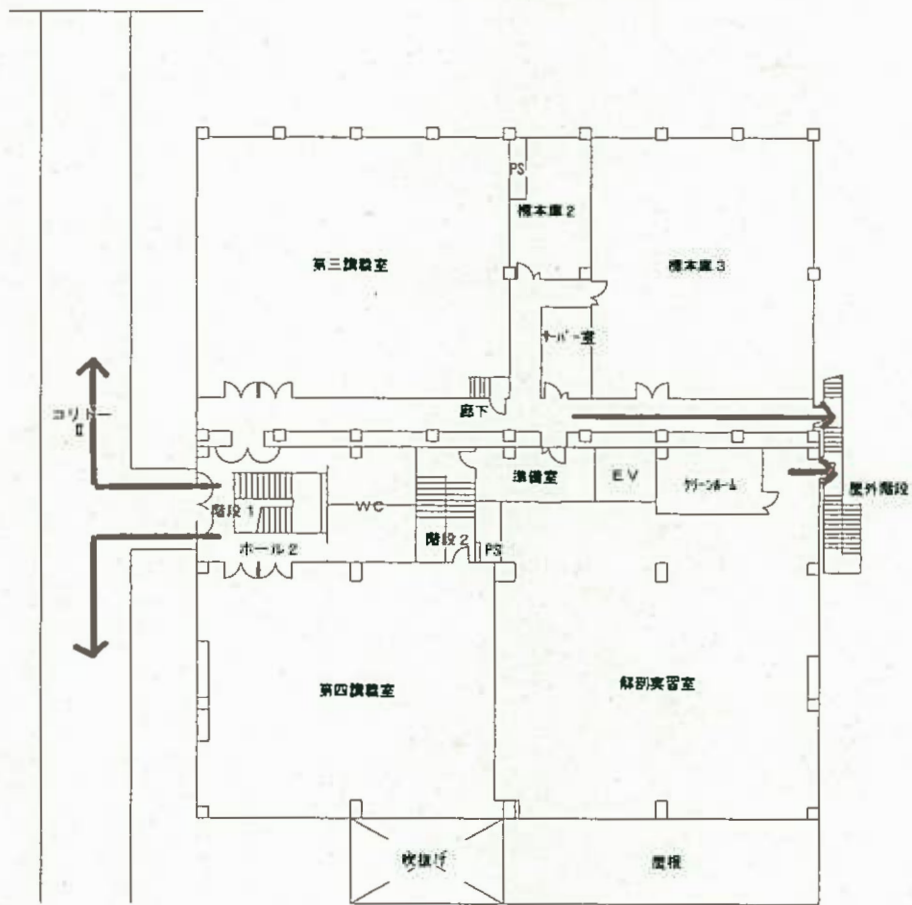

医学類G棟2階

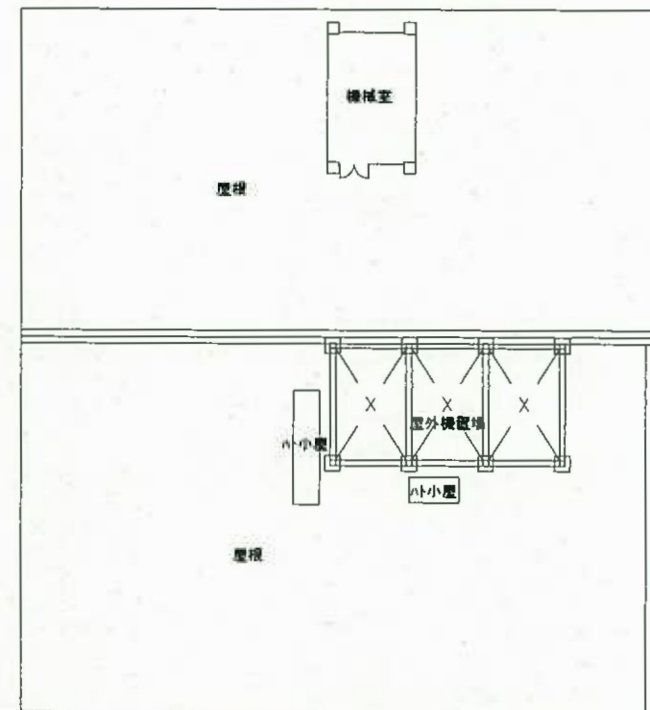

医学類G棟屋階

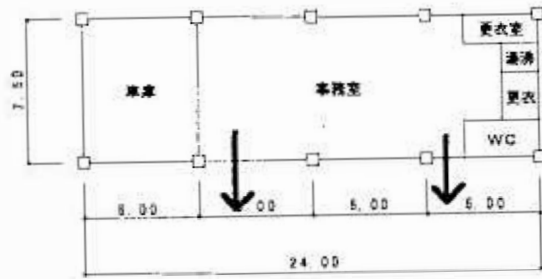

医学車庫平面図

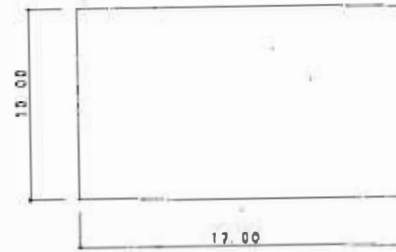

医学排水処理槽平面図

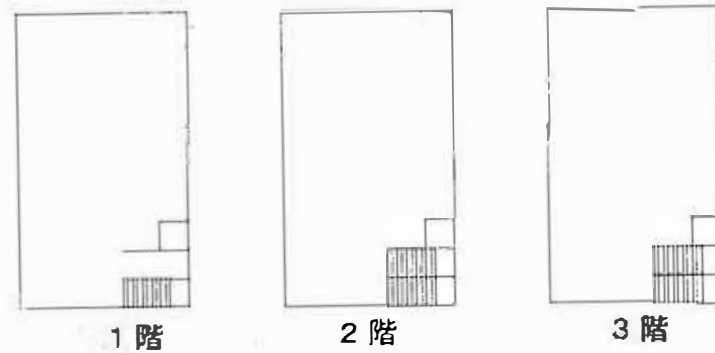

医学旧書庫1～3階平面図

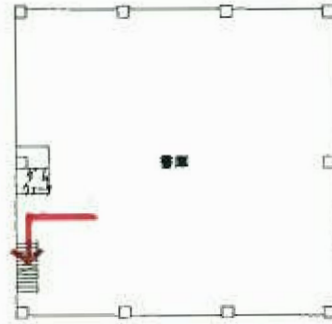

書庫 2階

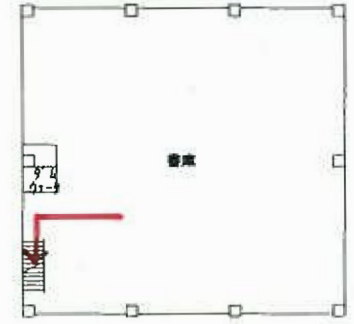

書庫 4階

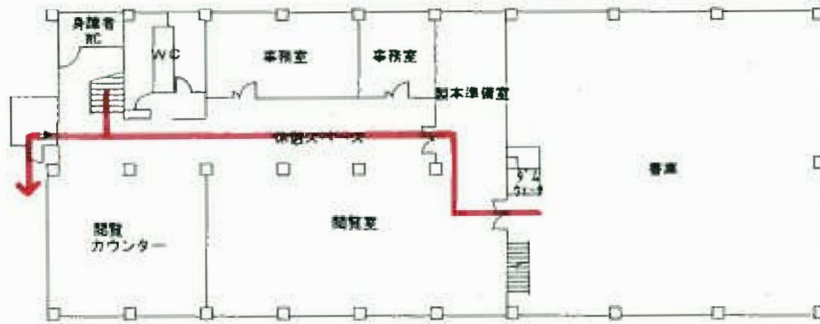

医学図書館 1階

書庫 1階

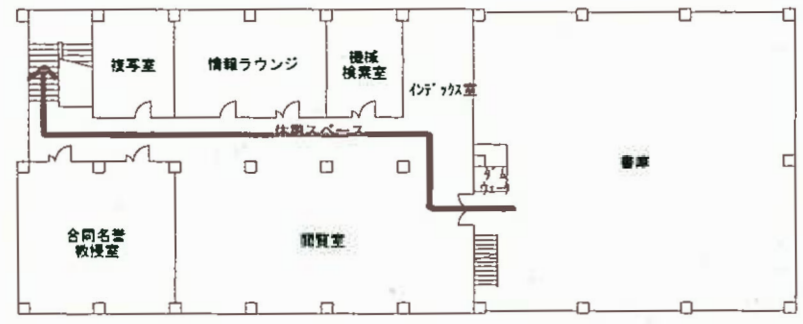

医学図書館 2階

書庫 3階

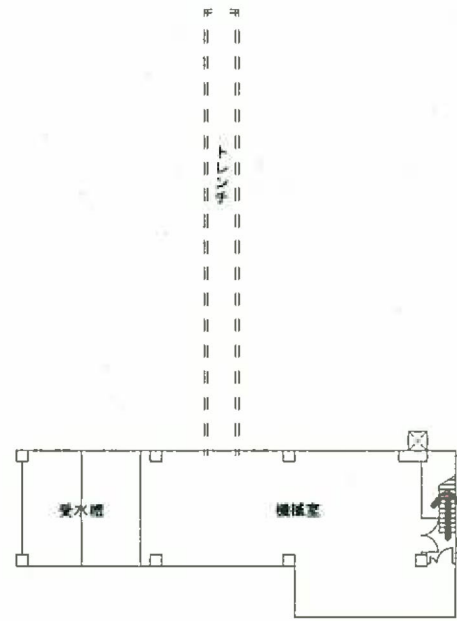

十全講堂地階

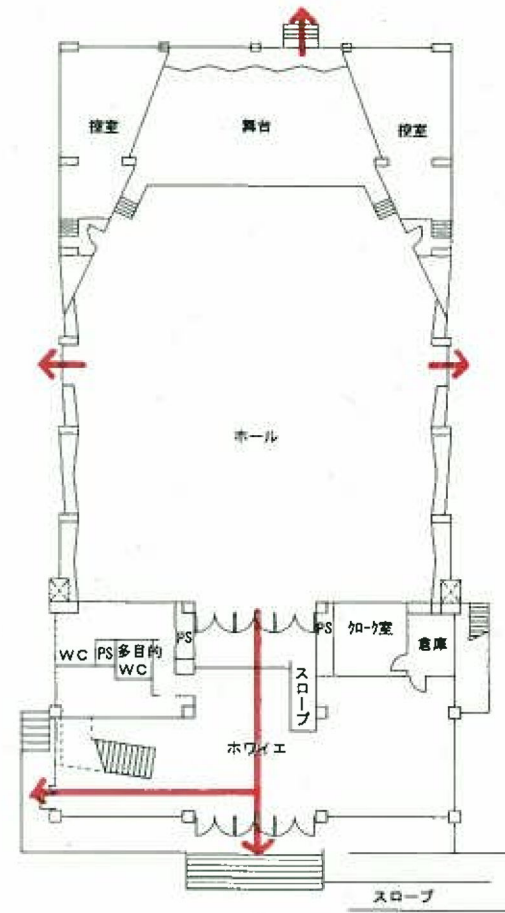

十全講堂1階

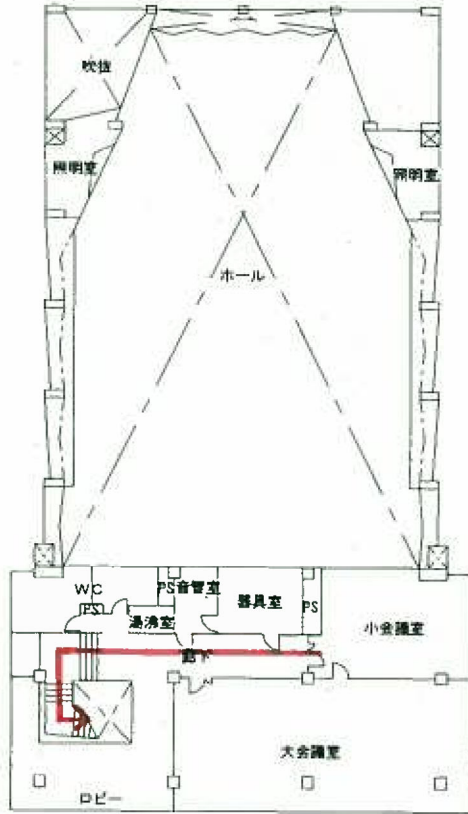

十全講堂 2階

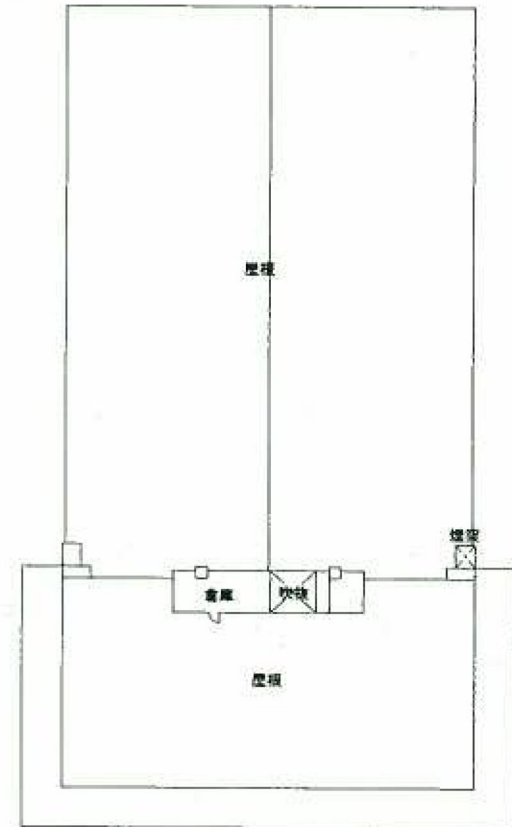

十全講堂屋階

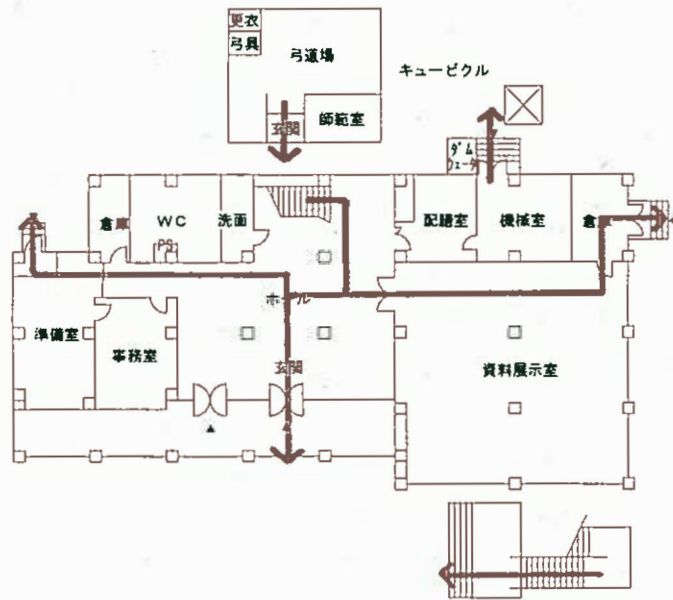

医学部記念館 1階

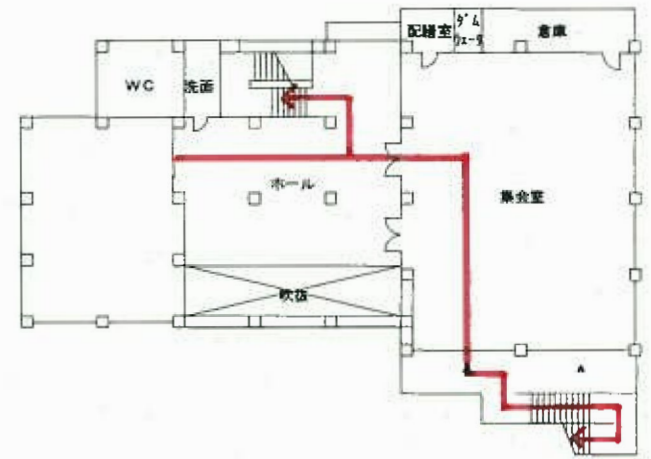

医学部記念館 2階

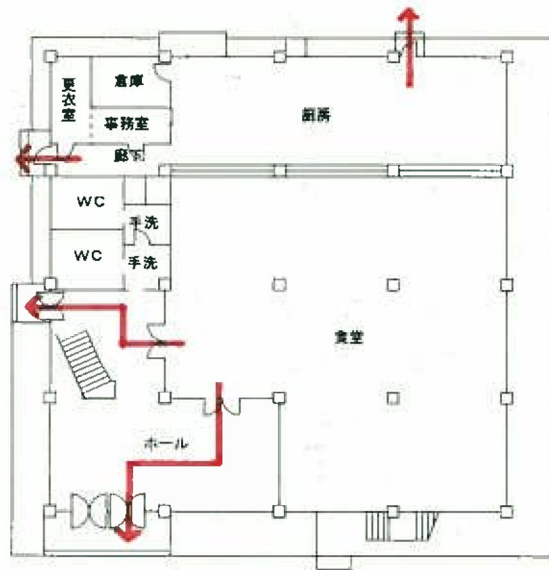

医学類福利施設 1階

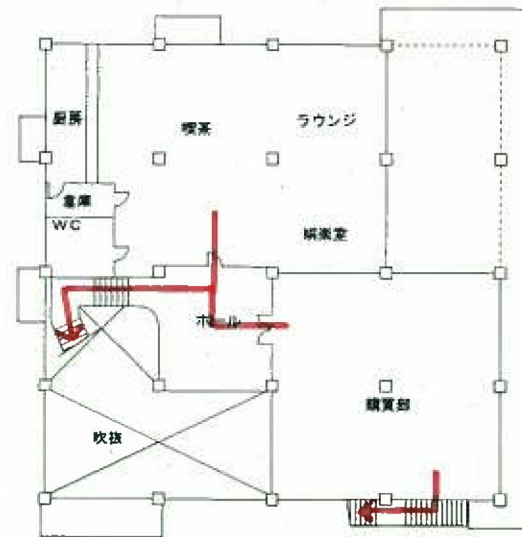

医学類福利施設 2階

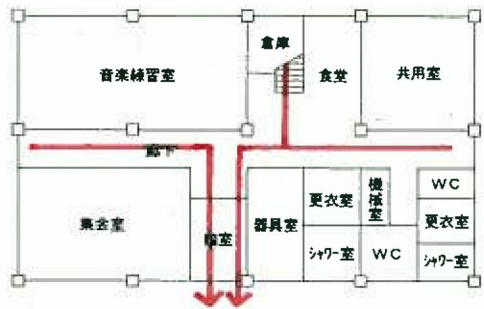

課外活動施設 1階

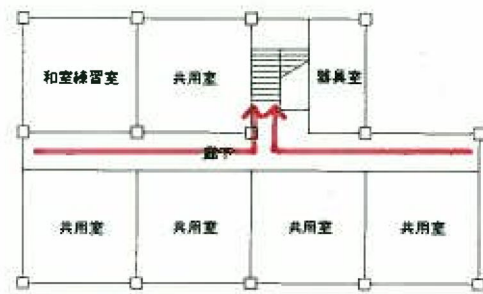

課外活動施設 2階

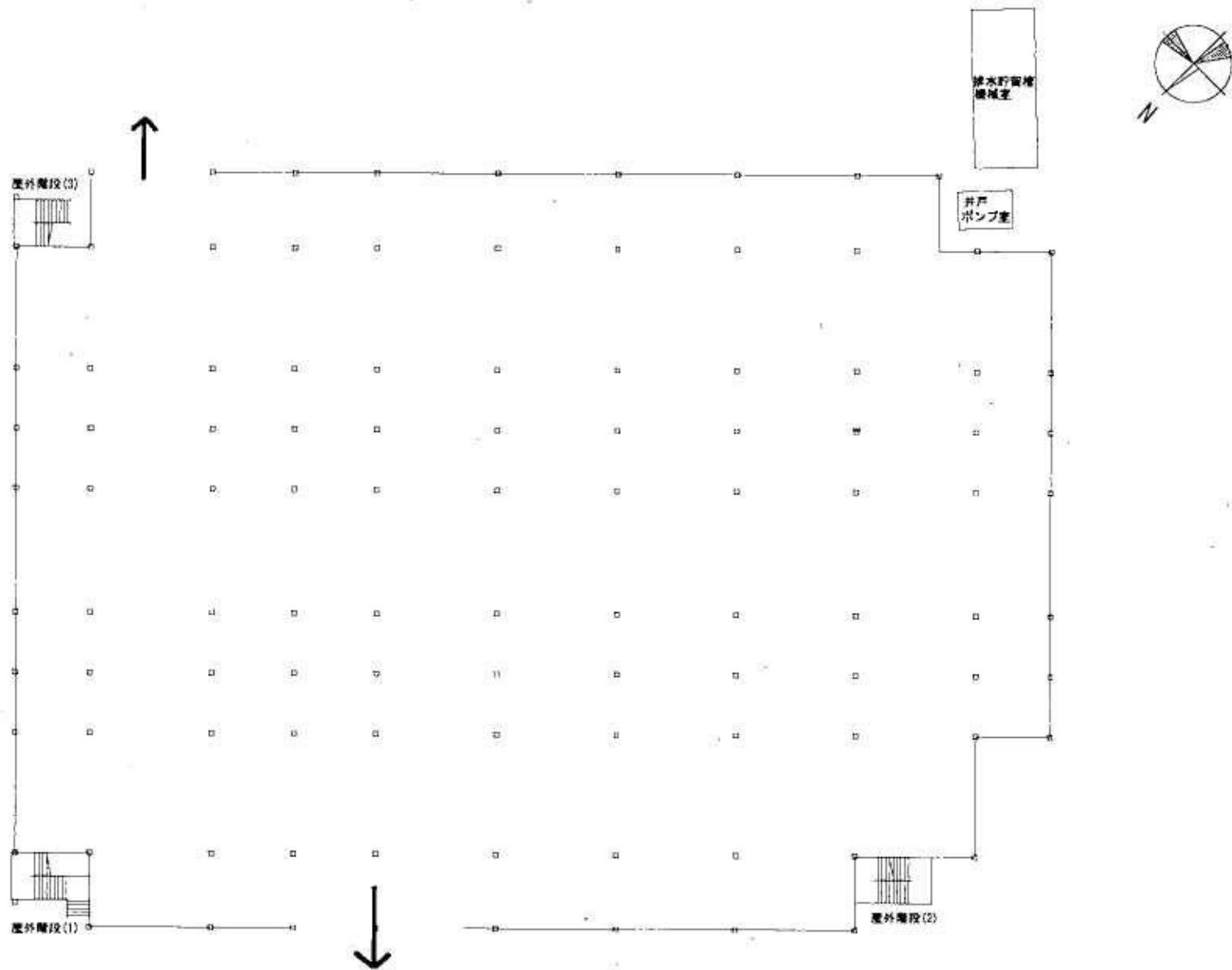

立体駐車場 1階

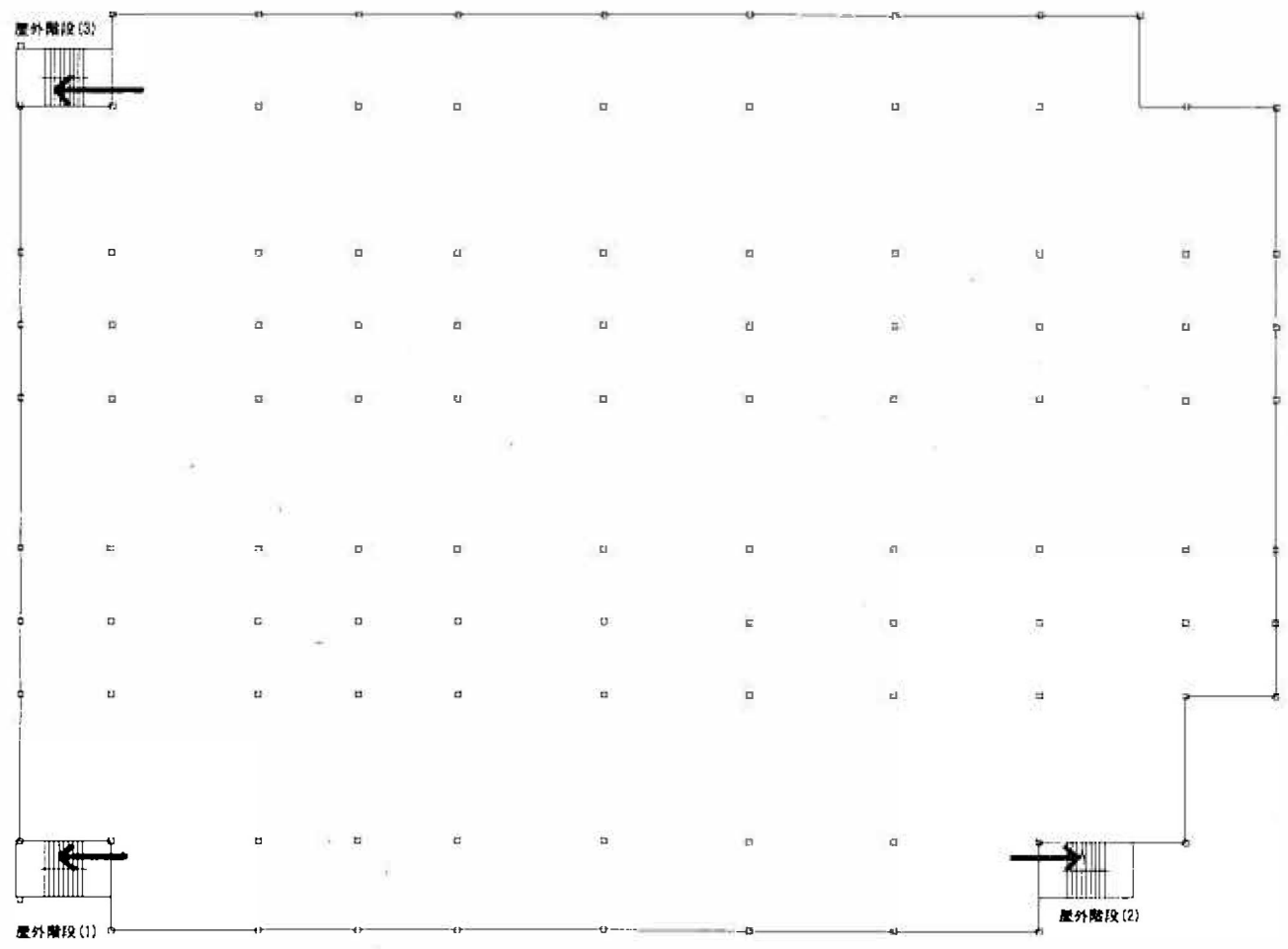

立体駐車場 2階平面図 S:1/400

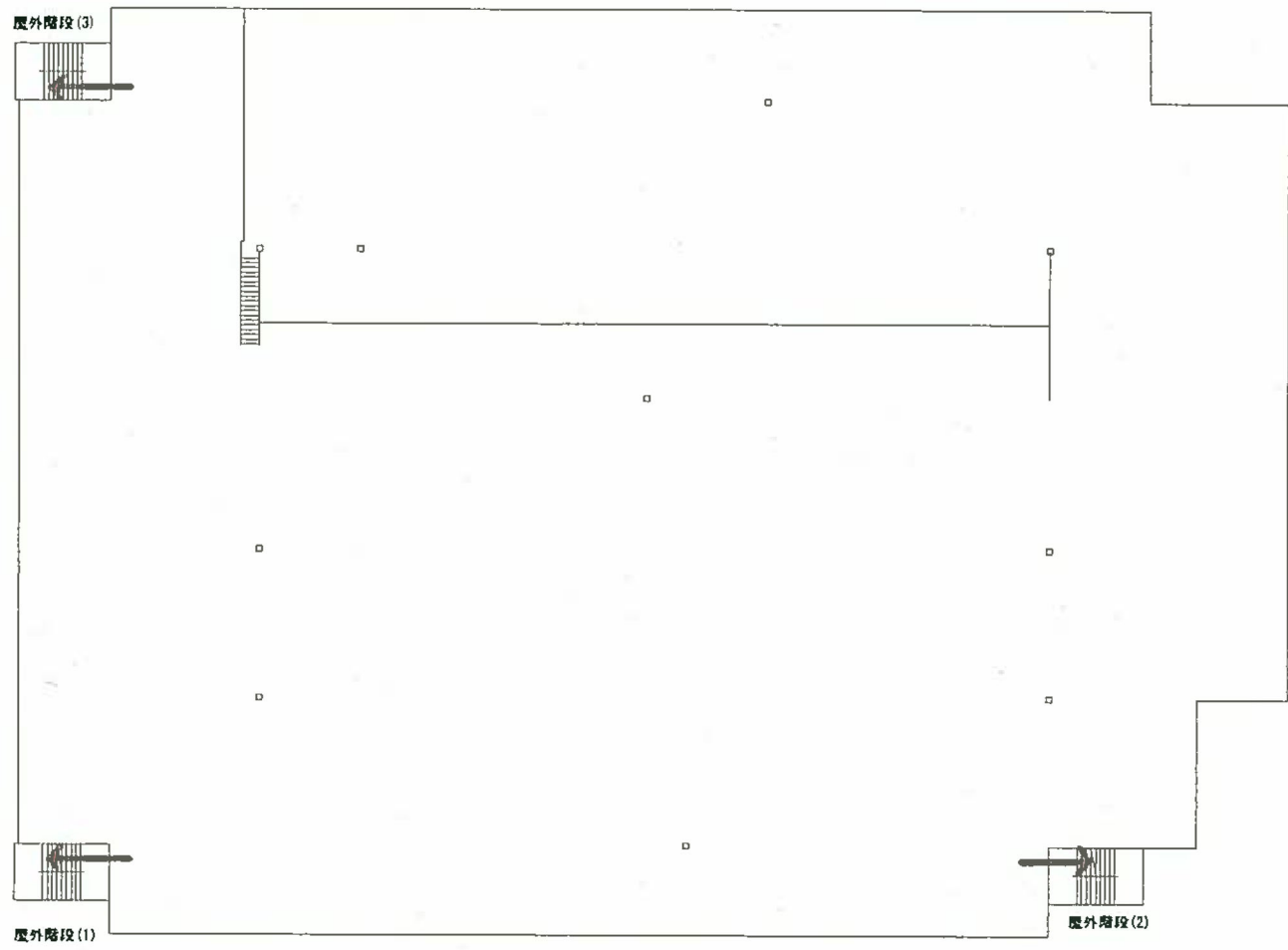
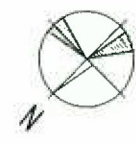

立体駐車場屋階

別図

アイソトープ総合研究施設 避難経路図

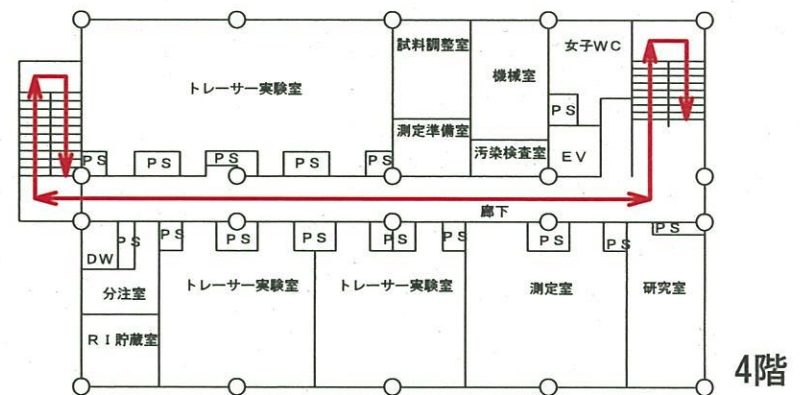
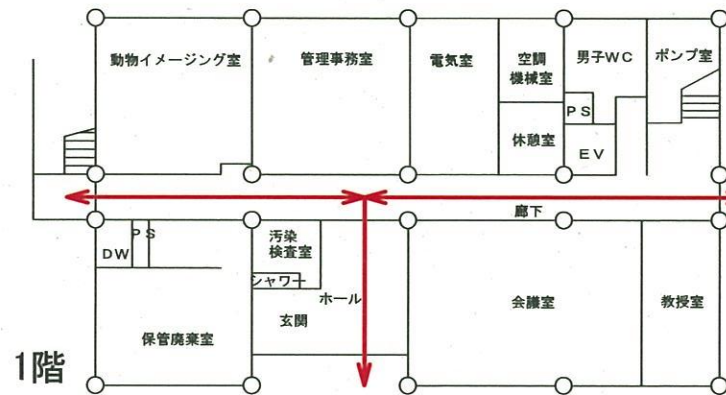
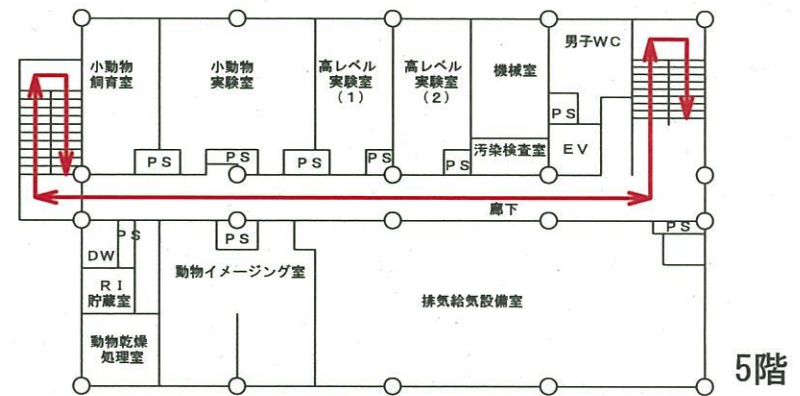
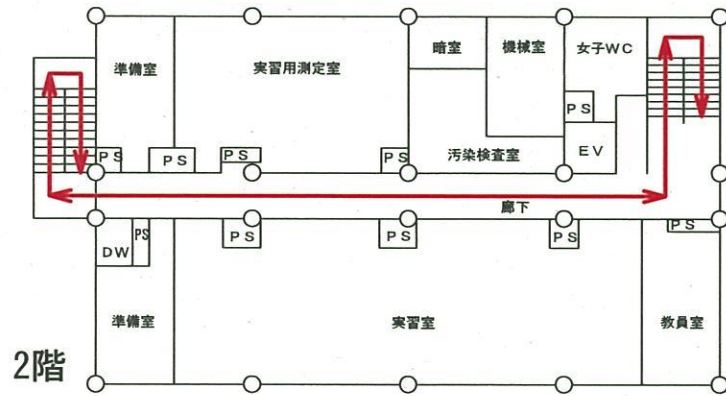
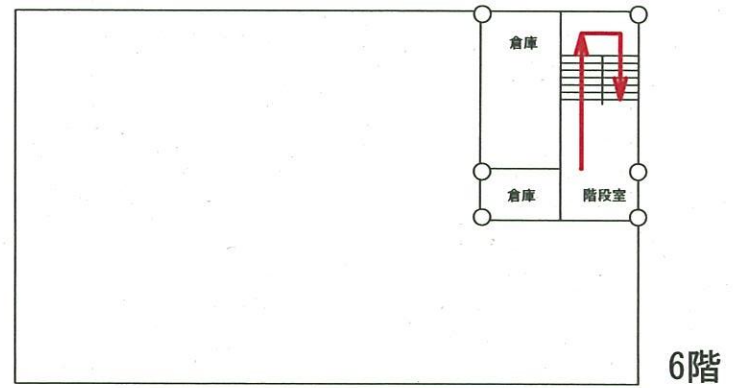
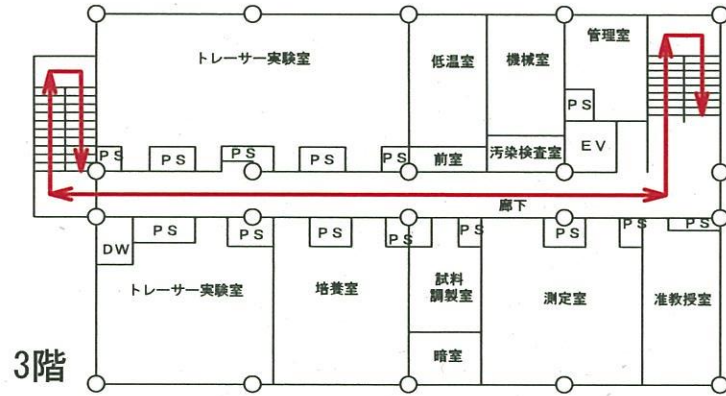

アイソトープ総合研究施設

別図

研究基盤支援施設 避難経路図

研究基盤支援施設

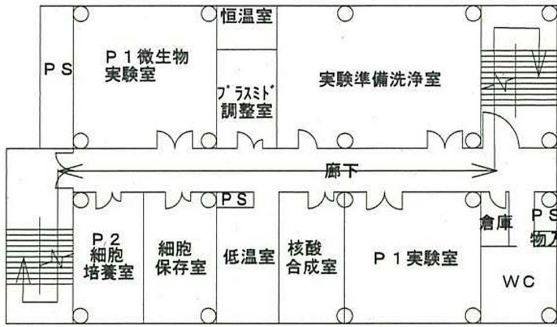

3階

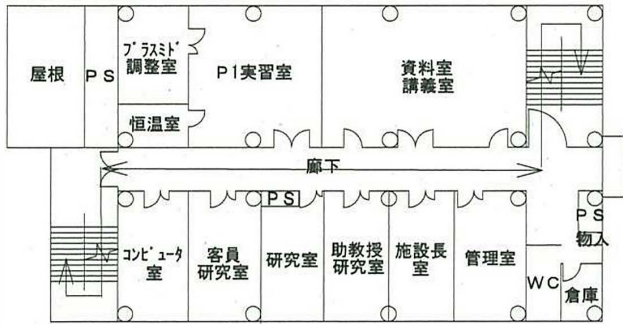

2階

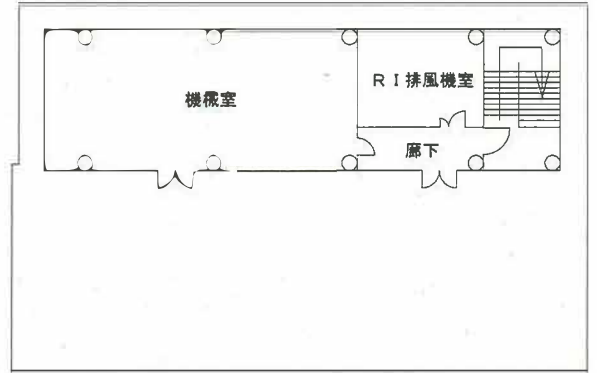

RF

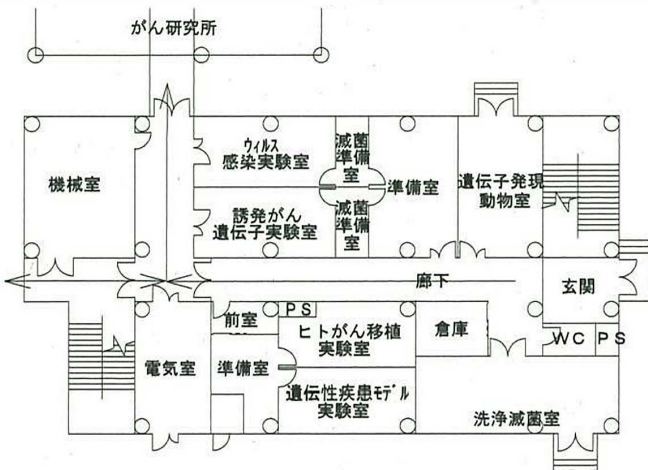

1階

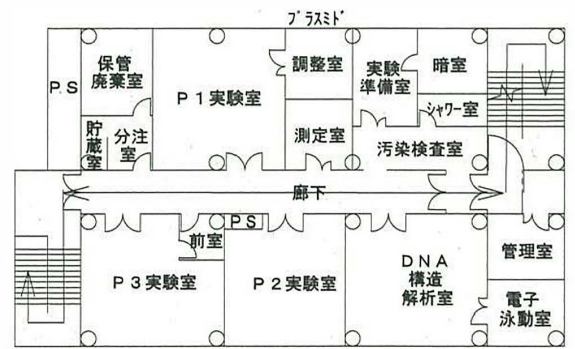

4階

別図

実験動物研究施設 避難経路図

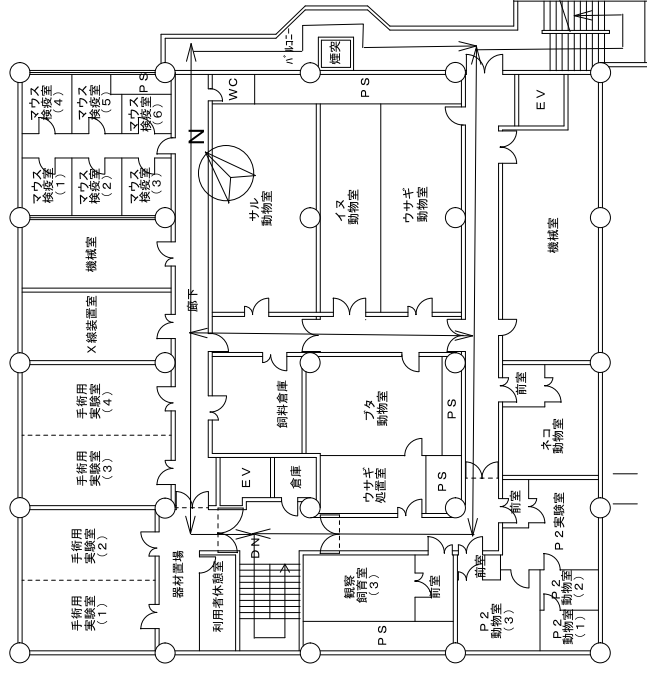

実験動物研究施設 2階

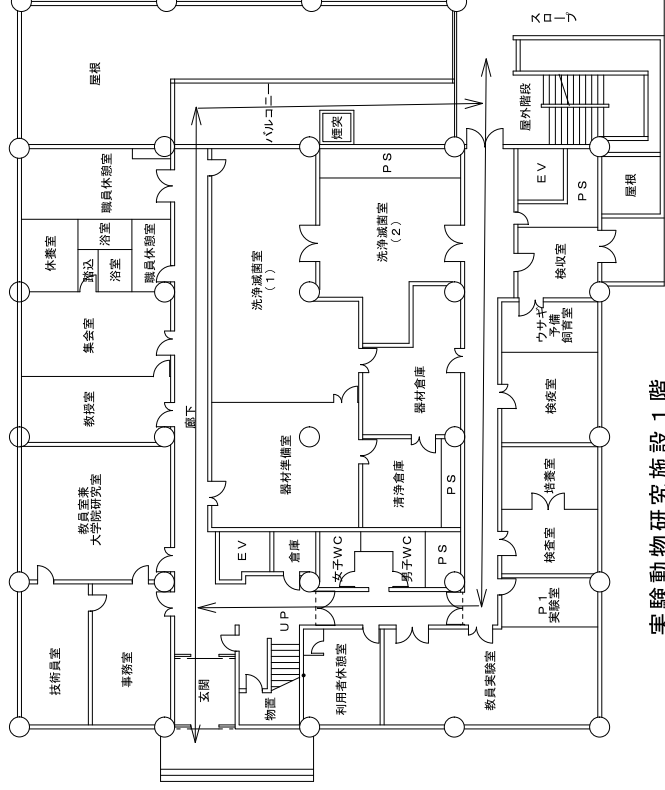

実験動物研究施設 1階

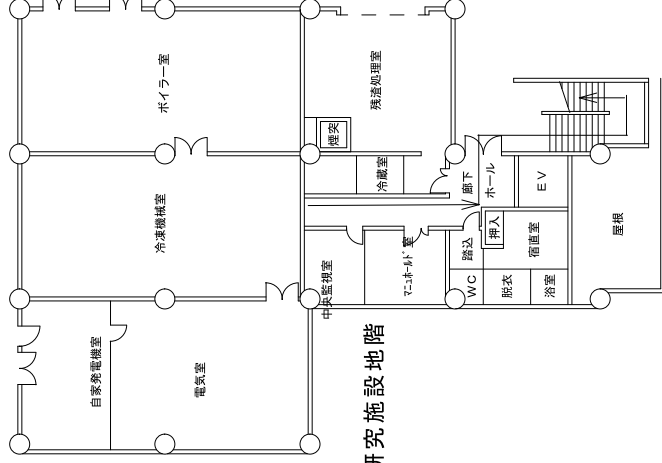

実験動物研究施設地階

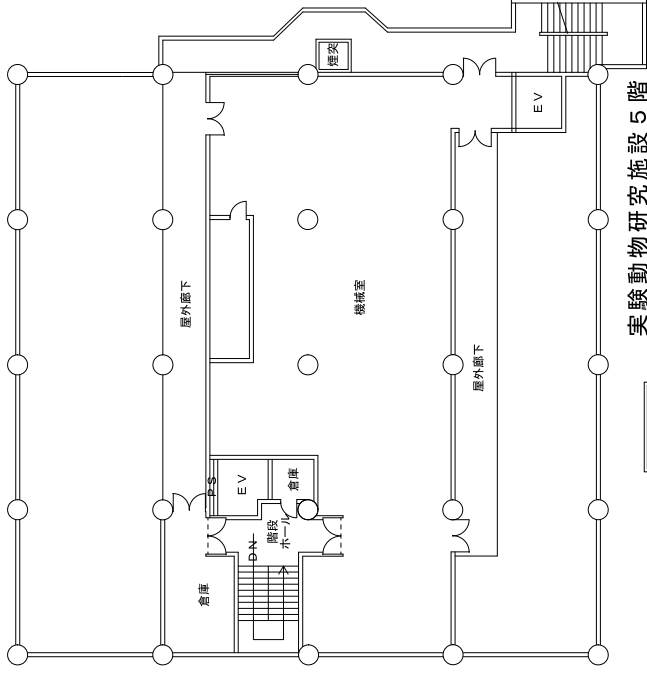

実験動物研究施設 5階

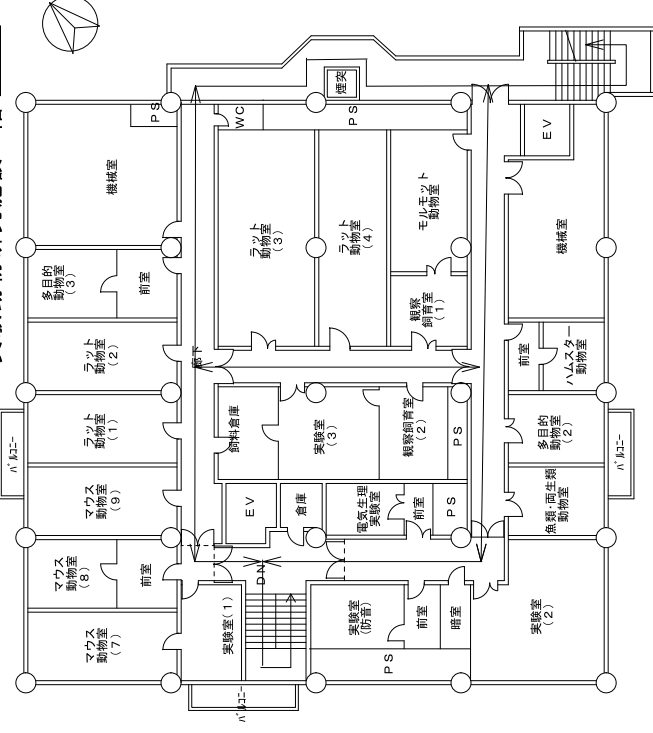

N

実験動物研究施設 4階

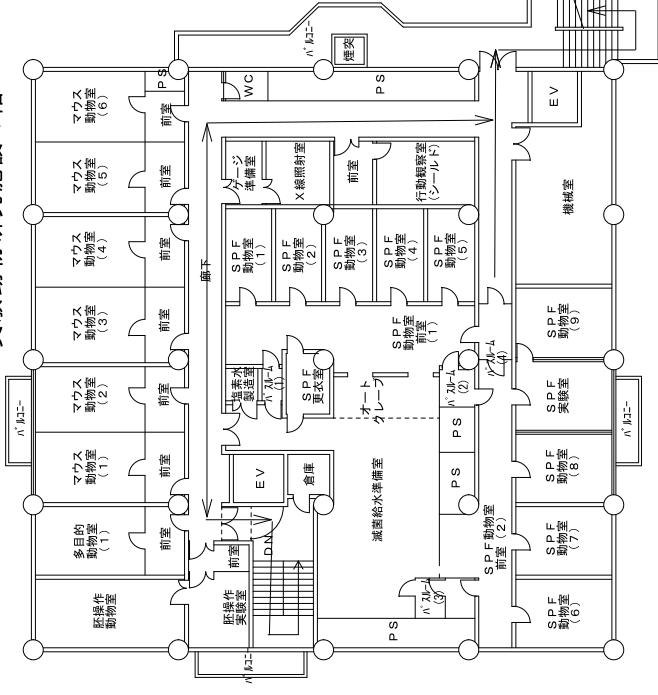

実験動物研究施設 3階

別図

保健学類棟避難経路図

保健学類 1号館

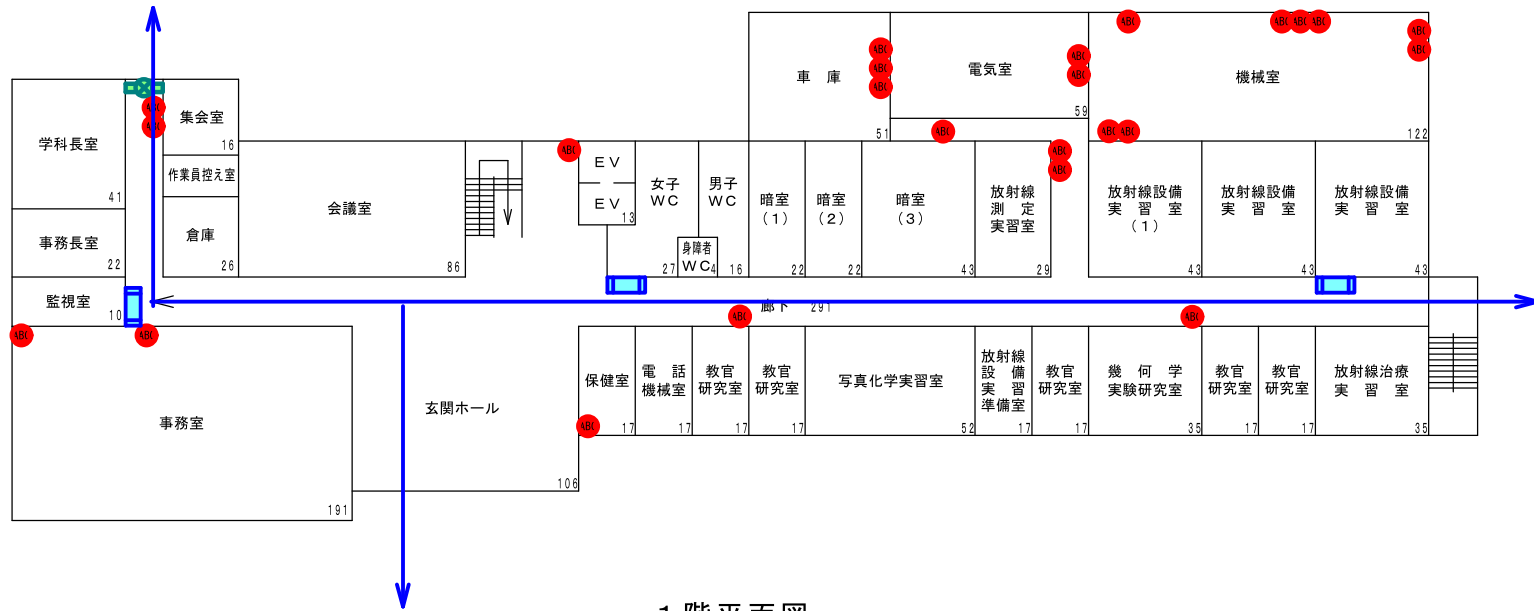

1階平面図

- 消火器
- 屋内消火栓
- ⊕ 非常口灯
- ➔ 避難経路

保健学類 1 号館



3階平面図

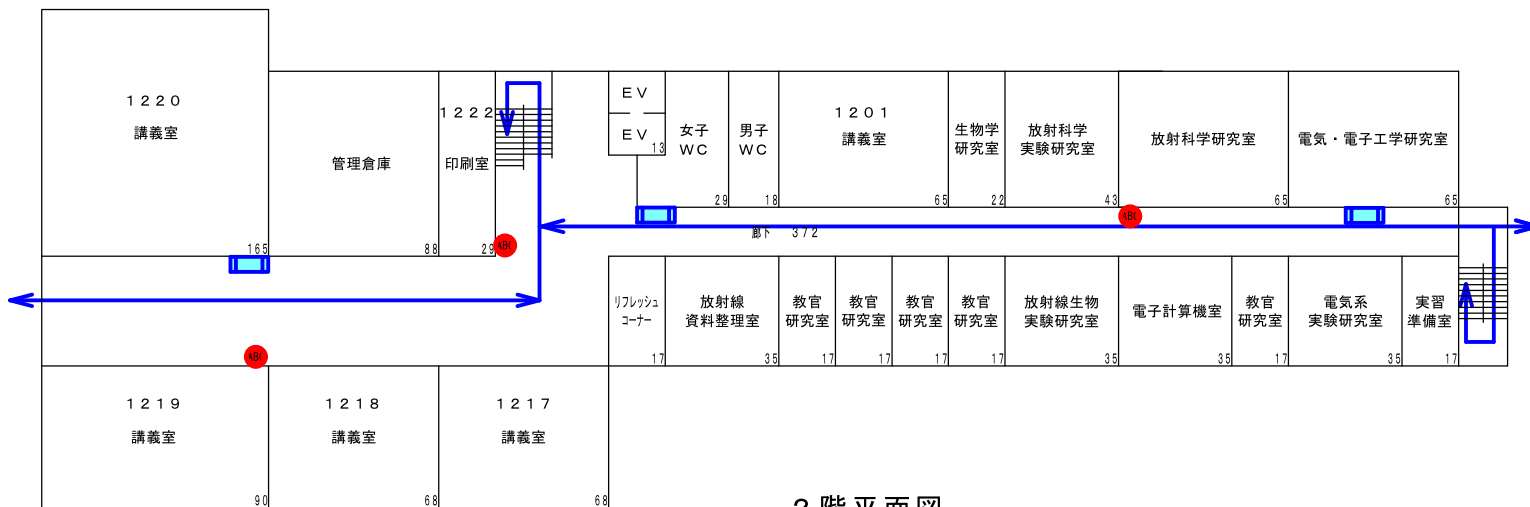

2階平面図

- 消火器
- 屋内消火栓
- 避難器具
- 避難経路

保健学類 1 号館



5階平面図



4階平面図

- 消火器
- 屋内消火栓
- 避難器具
- ➔ 避難経路

保健学類 1 号館



屋階平面図



- 4B 消火器
- 屋内消火栓
- X 避難器具
- 避難経路

6 階平面図

保健学類 2 号館

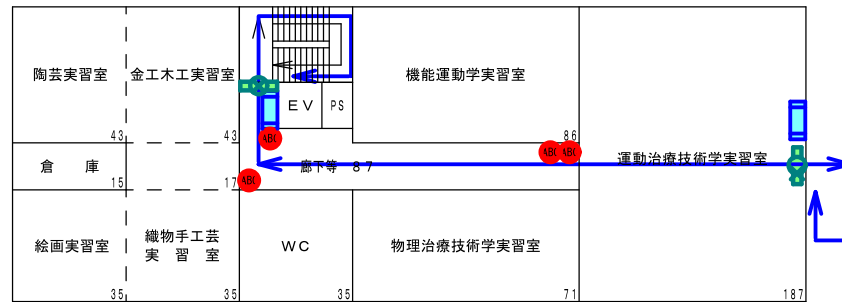

2階平面図

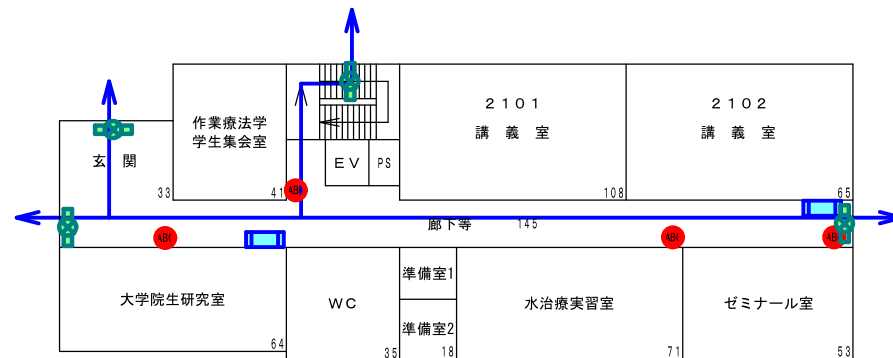

- 消火器
- 屋内消火栓
- 非常口灯
- ➔ 避難経路

1階平面図

保健学類 2 号館

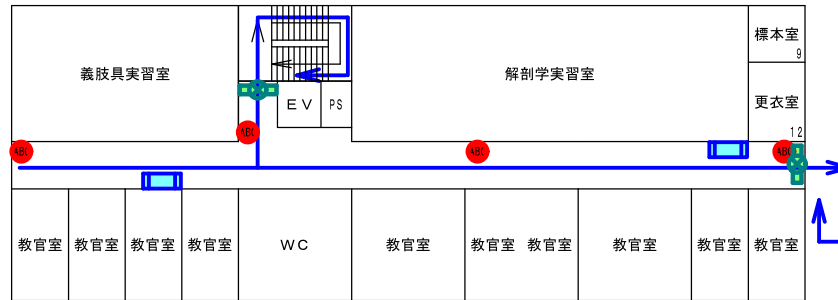

4 階平面図

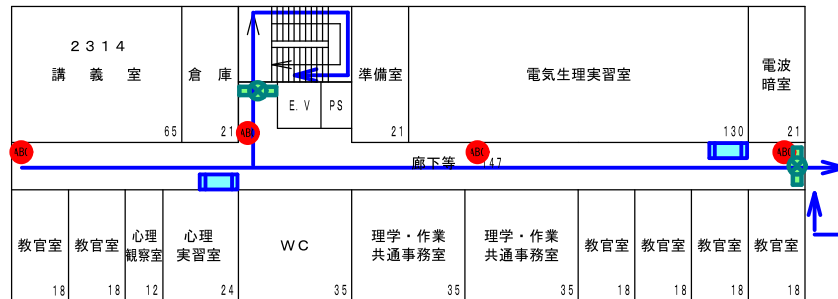

3 階平面図

- 4B 消火器
- 屋内消火栓
- 非常口灯
- 避難経路

保健学類 2 号館

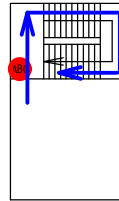

屋階平面図

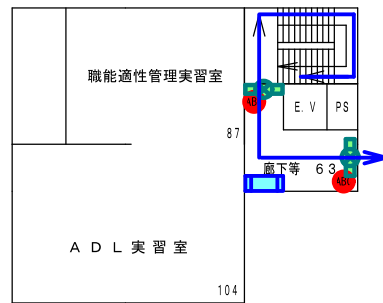

5階平面図

- 消火器
- 屋内消火栓
- 非常口灯
- 避難経路

保健学類 3 号館

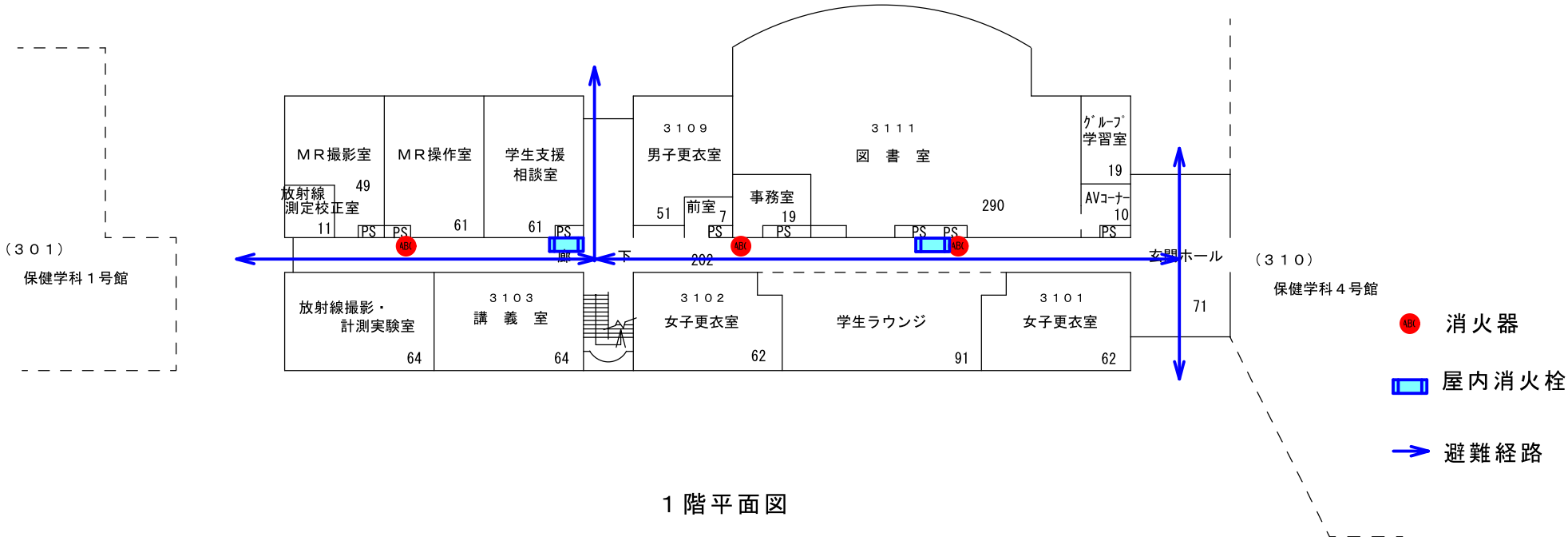

1 階平面図

保健学類 3 号館

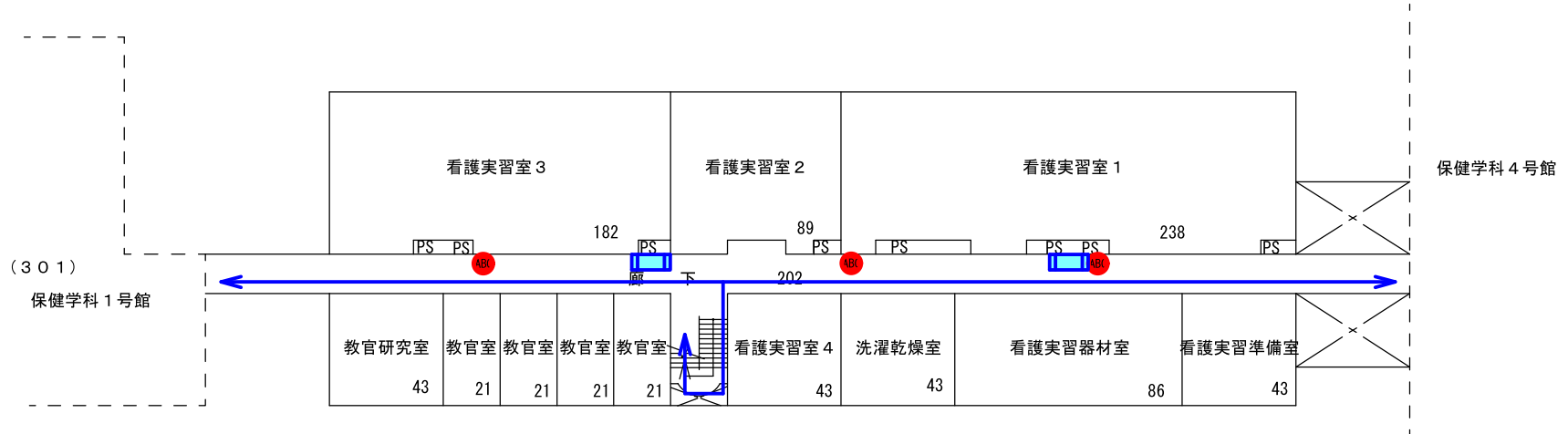

3階平面図

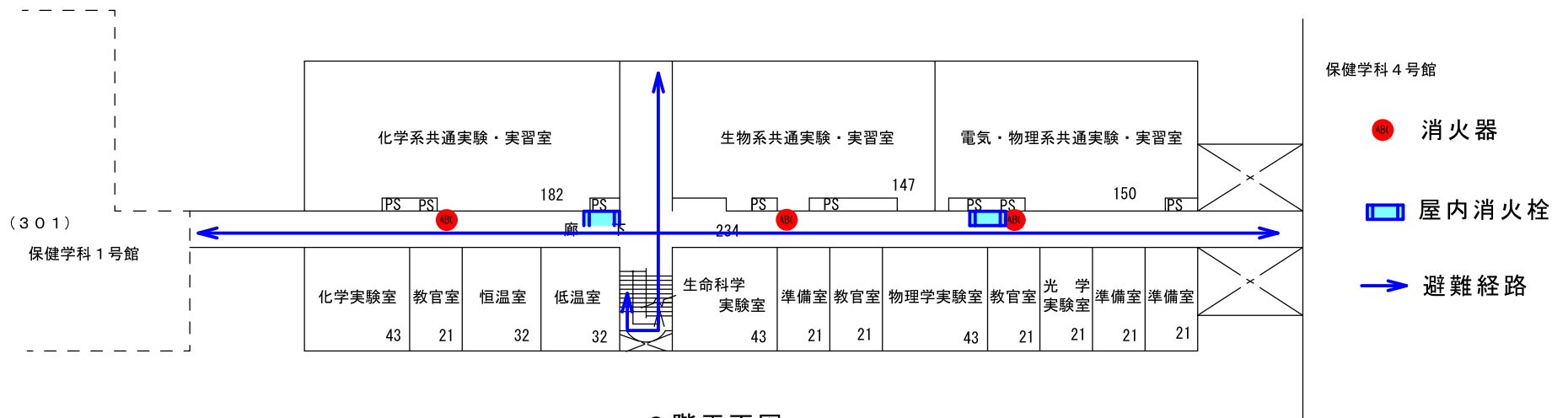

2階平面図

保健学類 4 号館

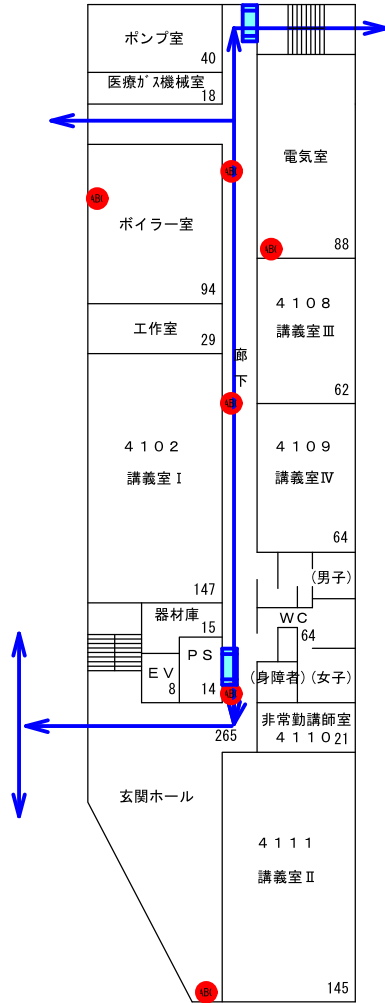

1 階平面図



2 階平面図

- 消火器
- 屋内消火栓
- 避難経路

保健学類 4 号館

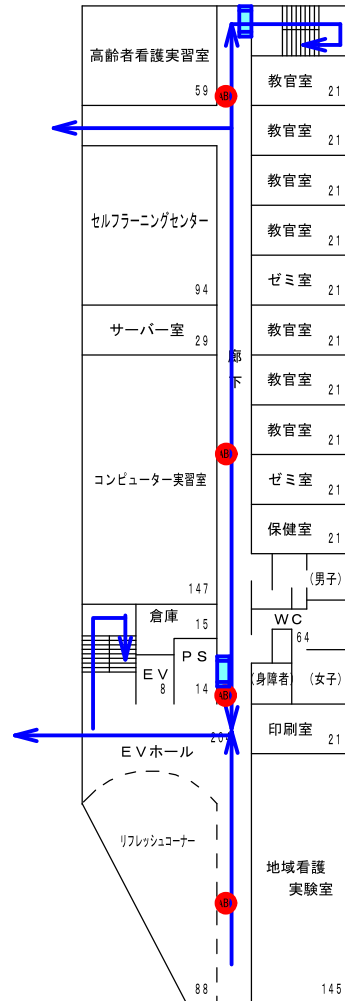

3階平面図



4階平面図

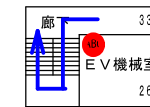

R階平面図

- 消火器
- 屋内消火栓
- 避難器具
- 避難経路

保健学類 5 号館

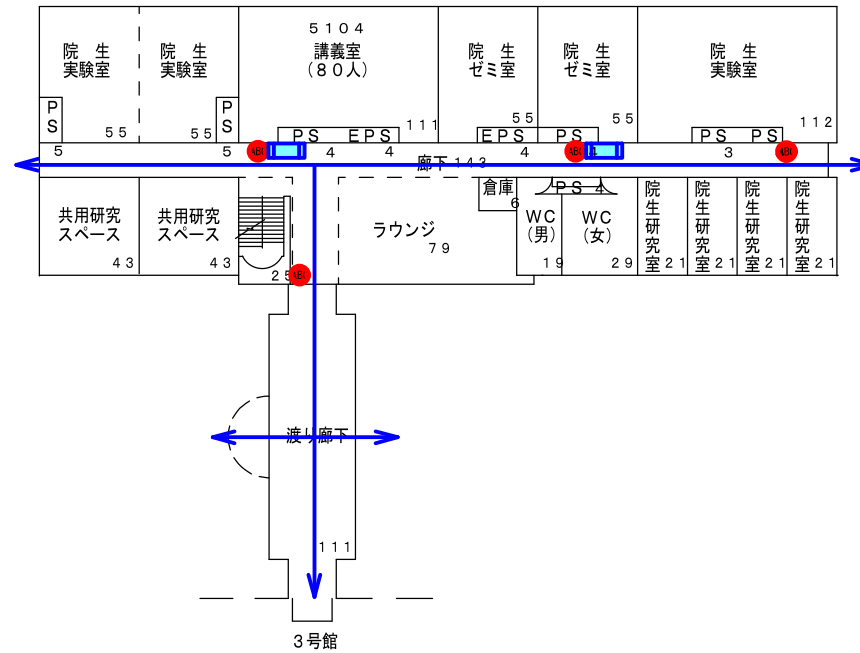

- 消火器
- 屋内消火栓
- 避難経路

1階平面図

保健学類 5 号 館

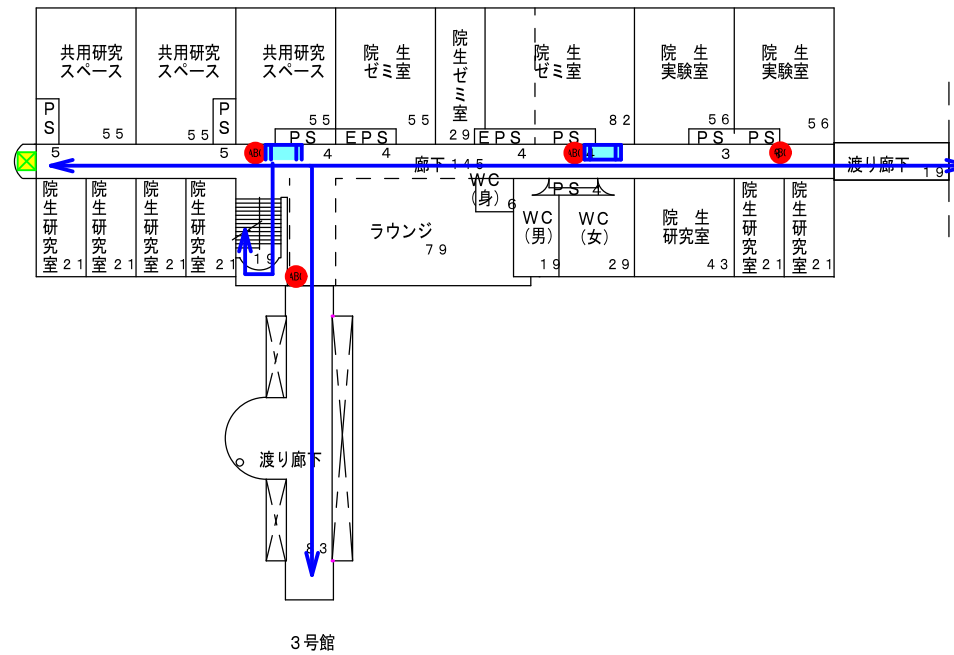

- 消火器
- 屋内消火栓
- 避難器具
- ➔ 避難経路

2階平面図

保健学類 5 号館

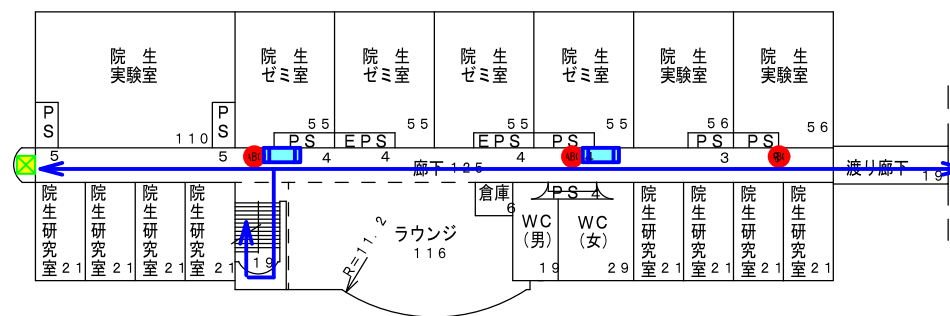

3 階平面図



- 消火器
- 屋内消火栓
- 避難器具
- 避難経路

体 育 館

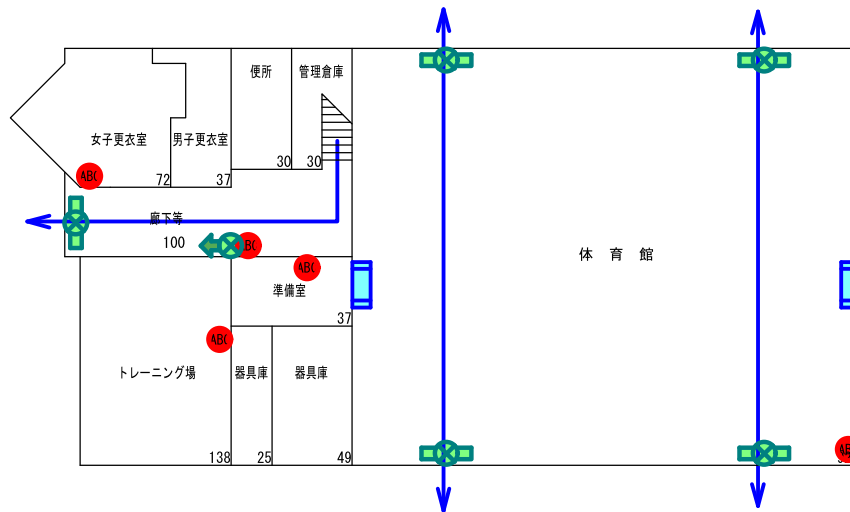

1 階平面図

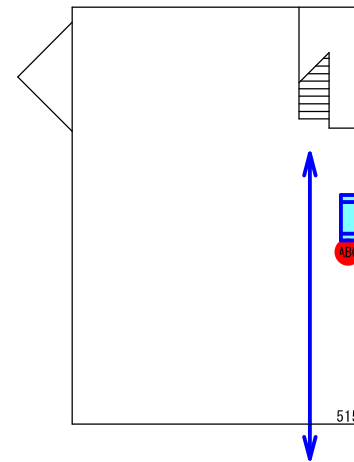

2 階平面図

-  消火器
-  屋内消火栓
-  非常口灯
-  避難経路

福利施設棟

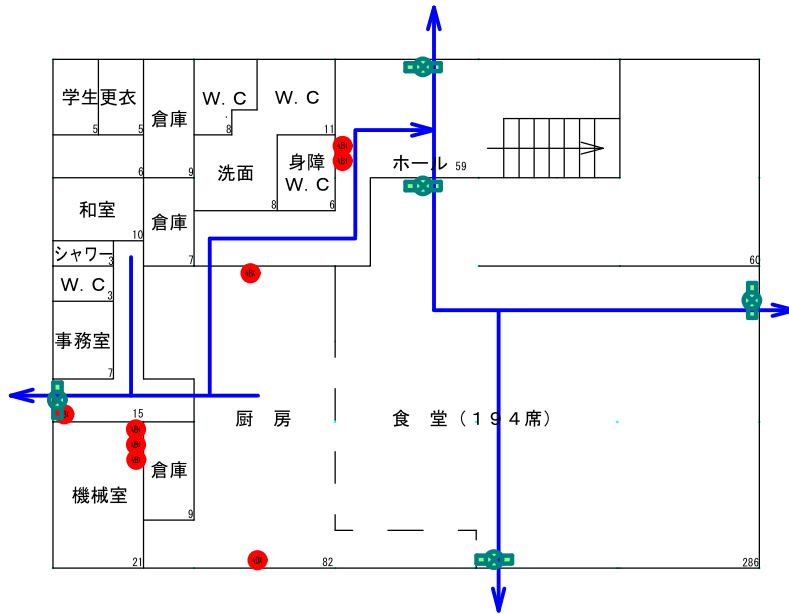

1階平面図

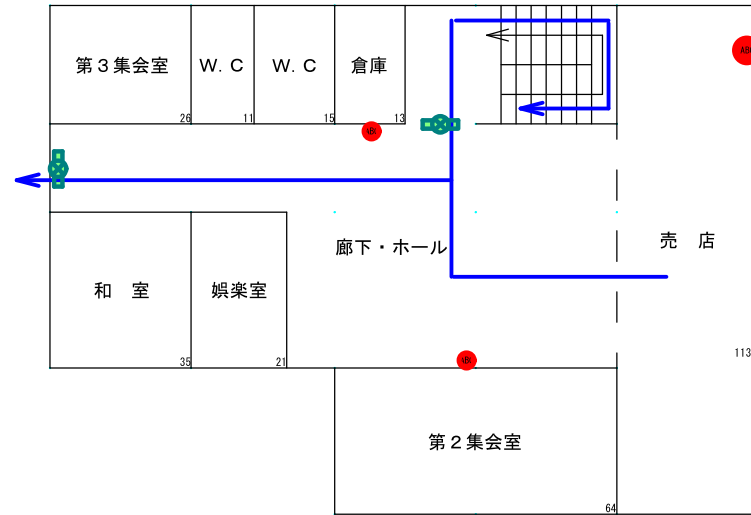

2階平面図

-  消火器
-  屋内消火栓
-  避難経路