

避難経路図 Evacuation Plan

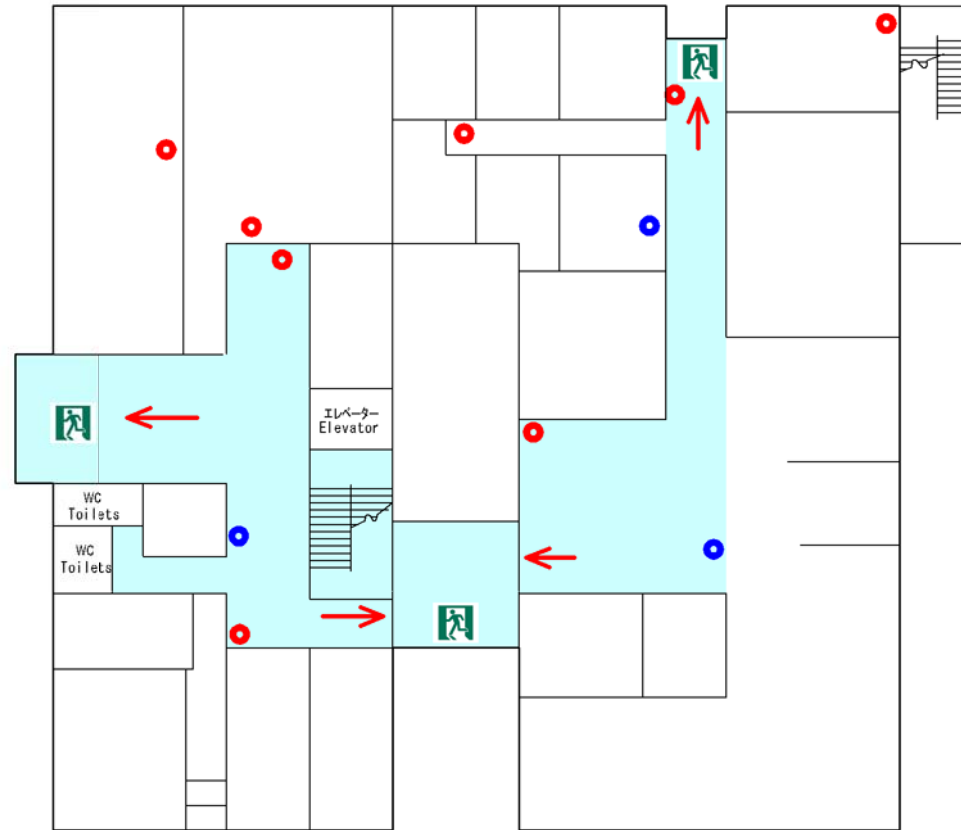

本部棟 1階平面図
Layout of 1st Floor, Administration Office

- 避難経路
(Evacuation Route)
- 消火器
(Fire Extinguisher)
- 消火栓
(Fire Hydrant)

避難経路図 Evacuation Plan

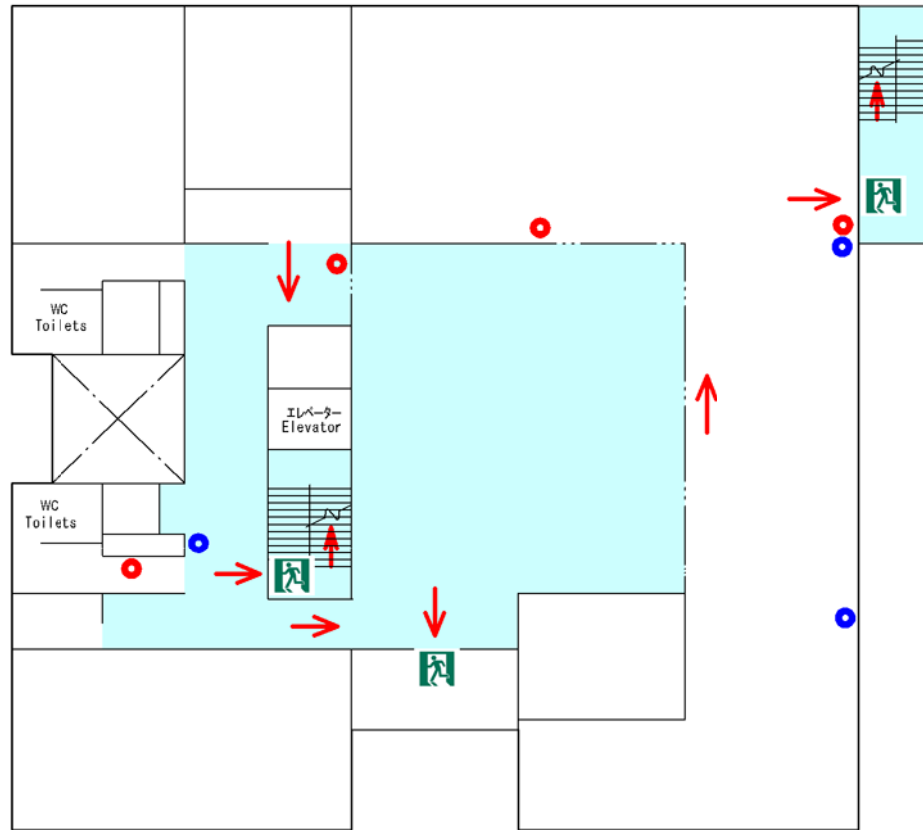

本部棟 2階平面図
Layout of 2nd Floor, Administration Office

- 避難経路
(Evacuation Route)
- 消火器
(Fire Extinguisher)
- 消火栓
(Fire Hydrant)

避難経路図
Evacuation Plan

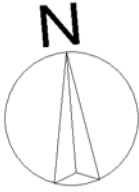
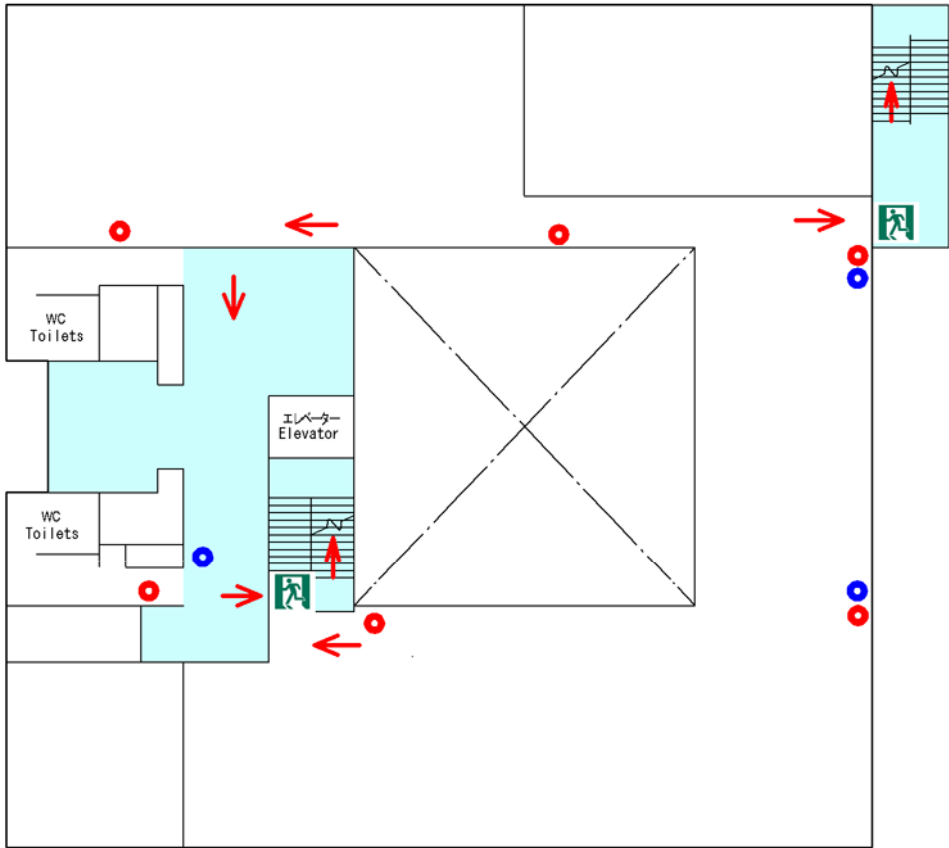

本部棟 3階平面図
Layout of 3rd Floor, Administration Office

- 避難経路
(Evacuation Route)
- 消火器
(Fire Extinguisher)
- 消火栓
(Fire Hydrant)

避難経路図 Evacuation Plan

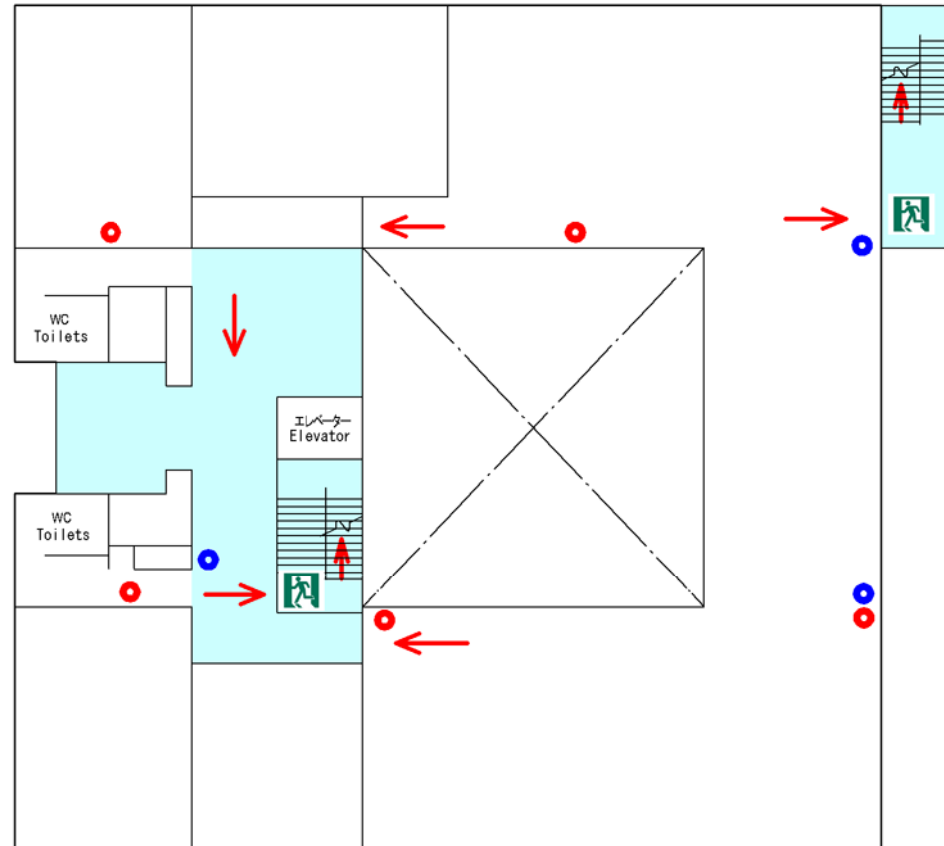

- 避難経路
(Evacuation Route)
- 消火器
(Fire Extinguisher)
- 消火栓
(Fire Hydrant)

本部棟 4階平面図
Layout of 4th Floor, Administration Office

避難経路図
Evacuation Plan

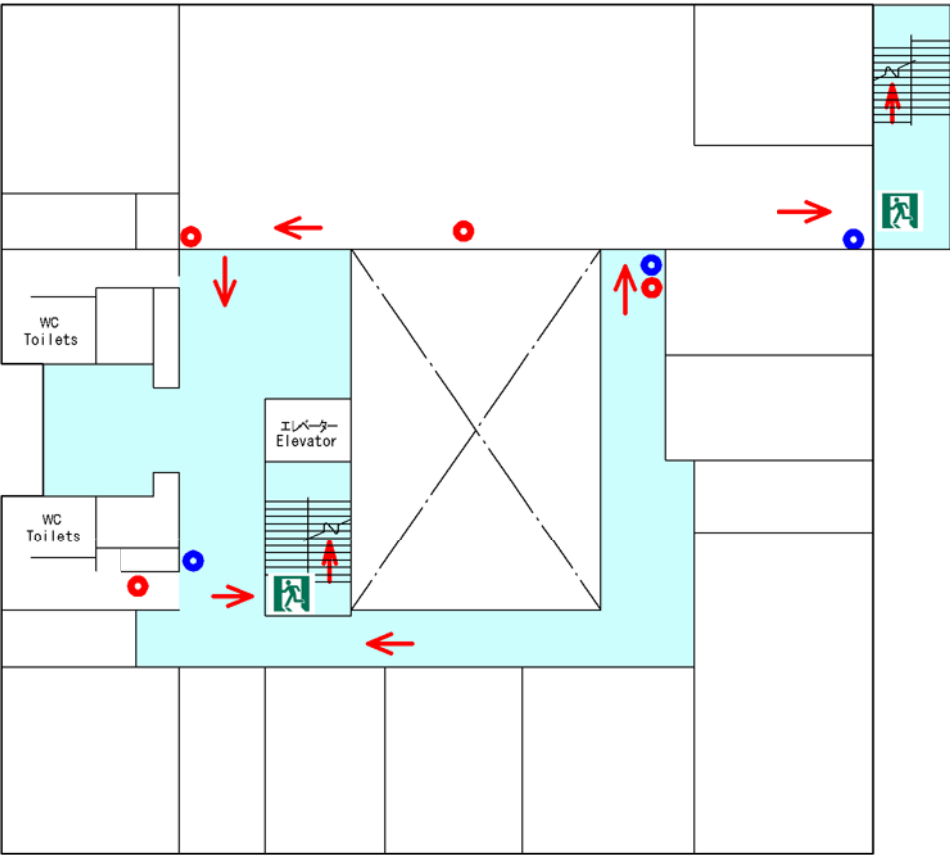
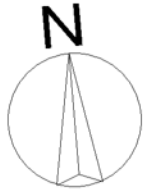

本部棟 5階平面図
Layout of 5th Floor, Administration Office

- 避難経路
(Evacuation Route)
- 消火器
(Fire Extinguisher)
- 消火栓
(Fire Hydrant)

避難経路図 Evacuation Plan

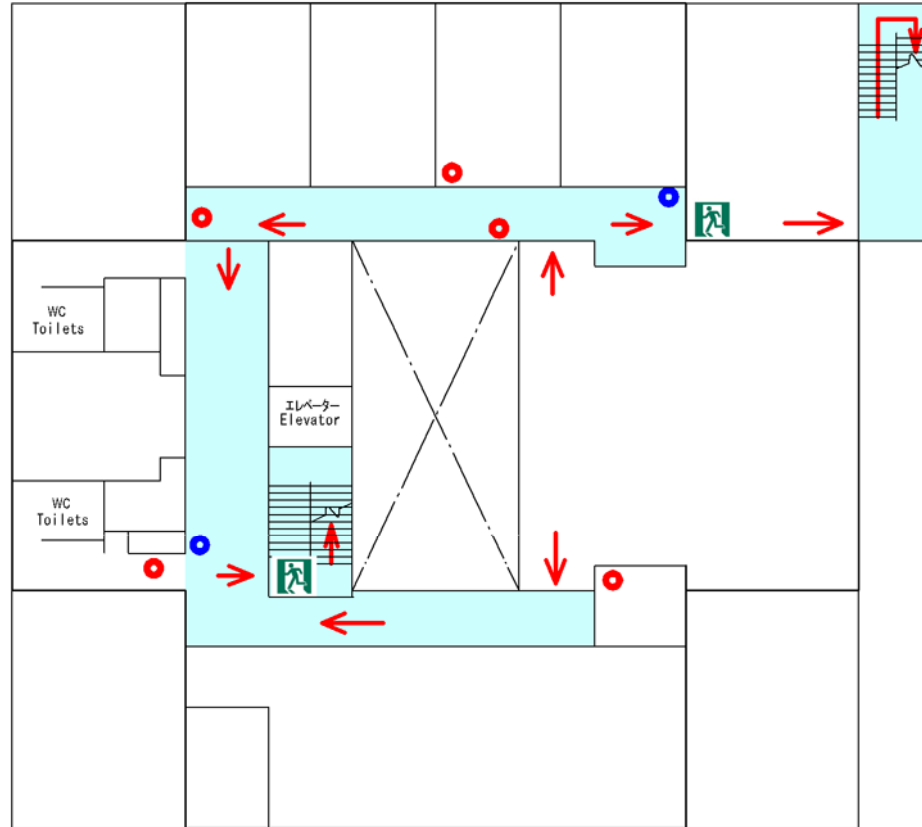

本部棟 6階平面図
Layout of 6th Floor, Administration Office

- 避難経路
(Evacuation Route)
- 消火器
(Fire Extinguisher)
- 消火栓
(Fire Hydrant)

避難経路図 Evacuation Plan

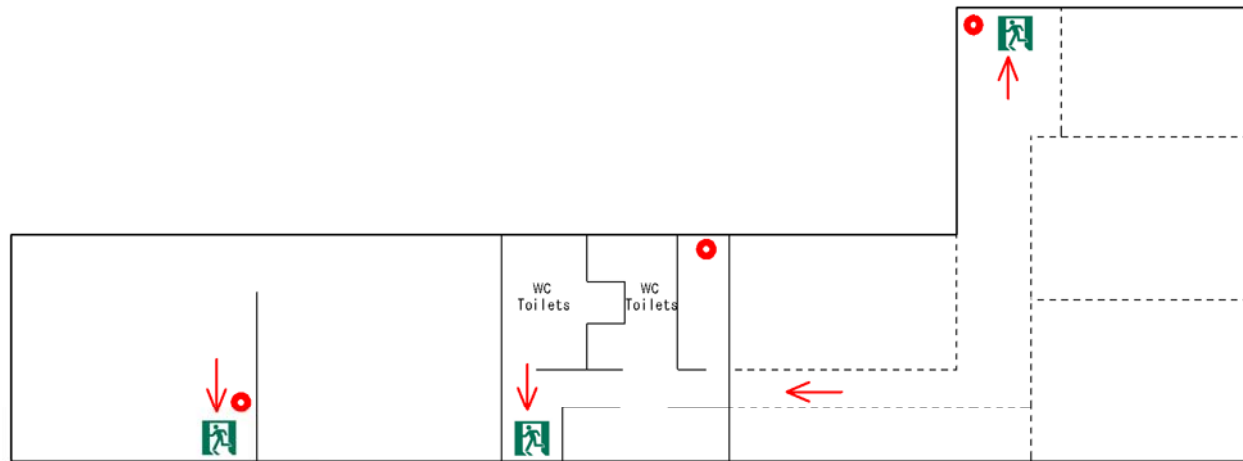

- 避難経路
(Evacuation Route)
- 消火器
(Fire Extinguisher)

本部棟 2 1階平面図
Layout of 1st Floor, Administration Office 2

避難経路図 Evacuation Plan

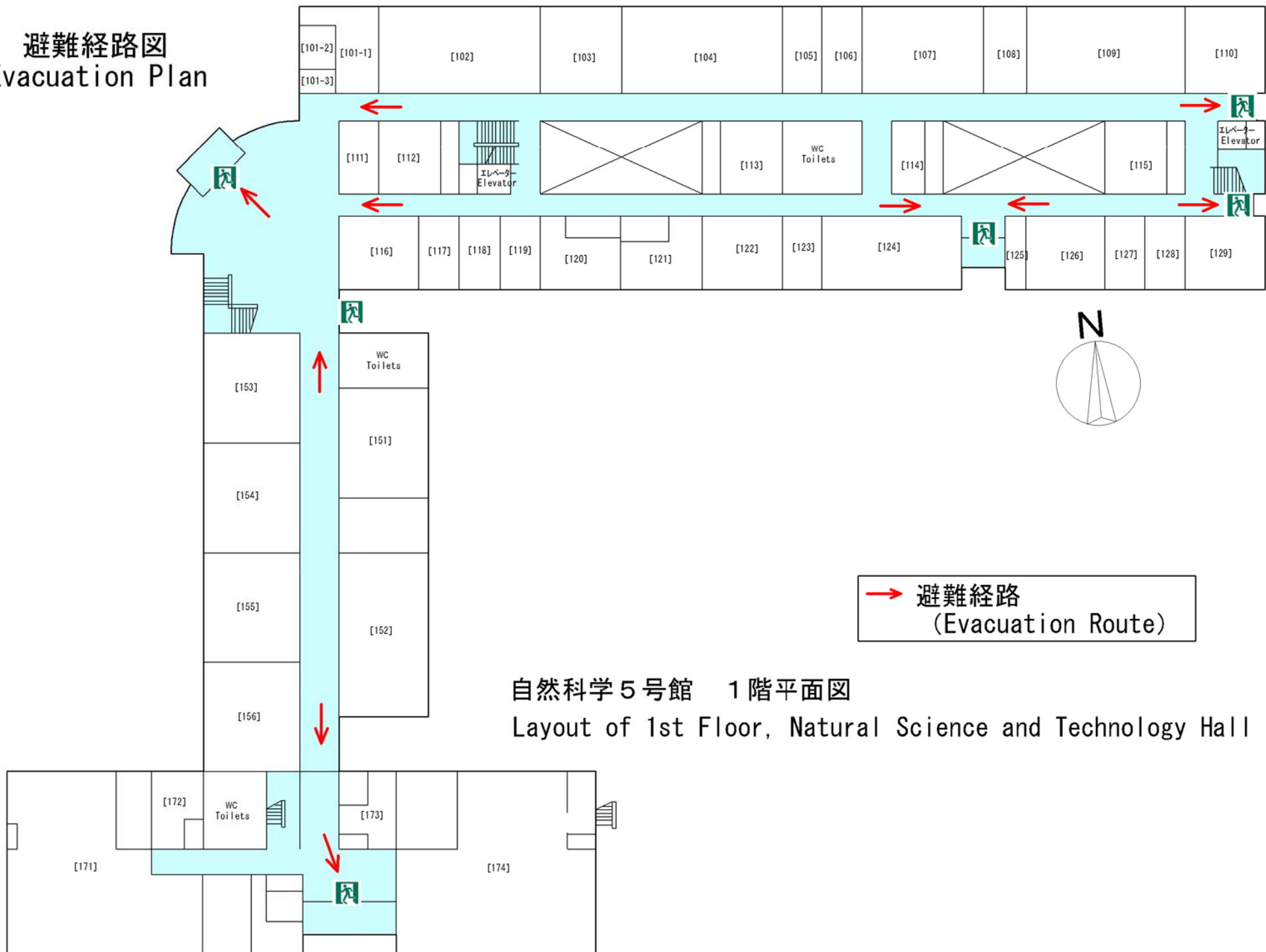

自然科学5号館 1階平面図

Layout of 1st Floor, Natural Science and Technology Hall 5

避難経路図 Evacuation Plan

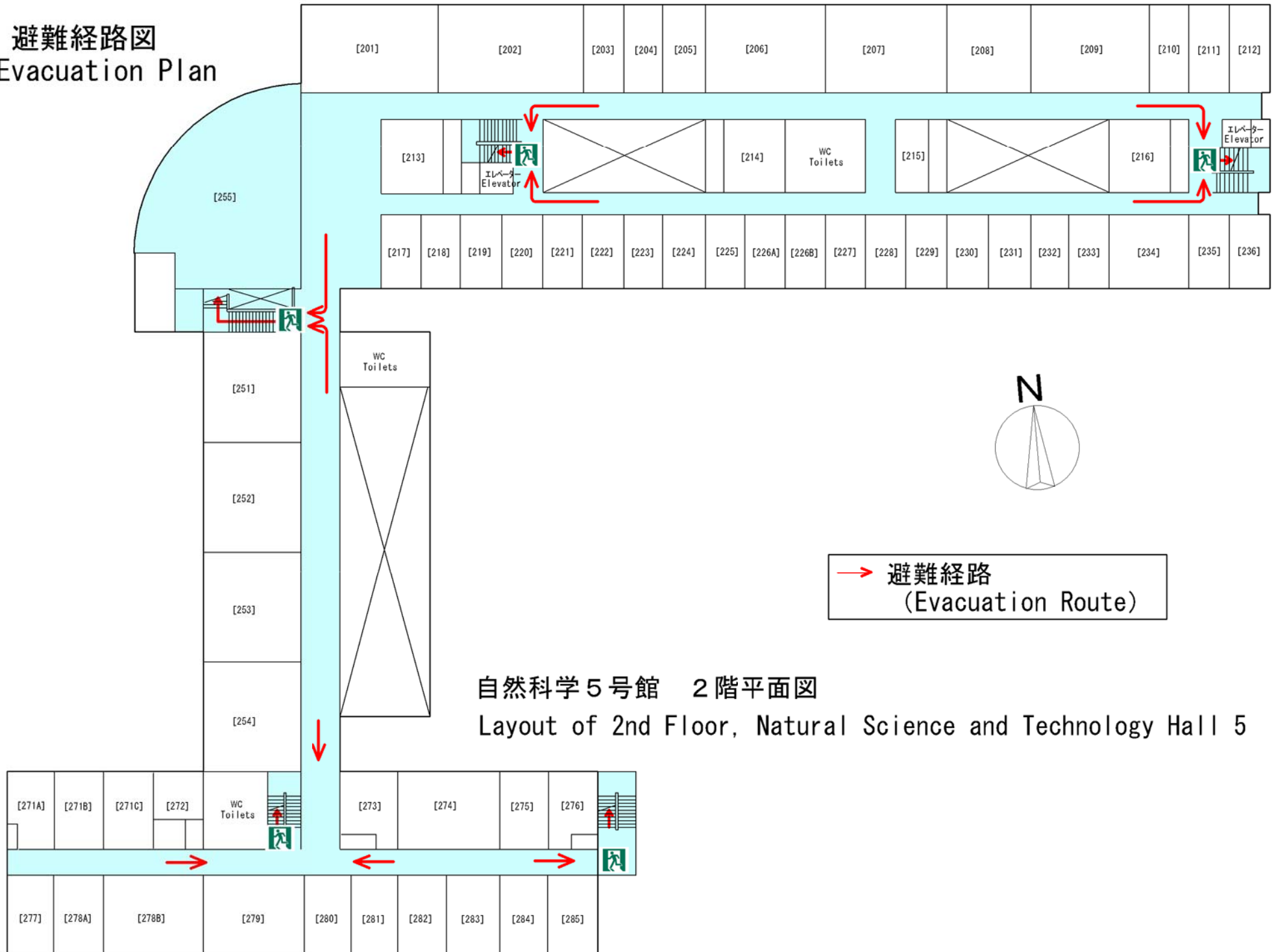

自然科学5号館 2階平面図

Layout of 2nd Floor, Natural Science and Technology Hall 5

避難経路図 Evacuation Plan

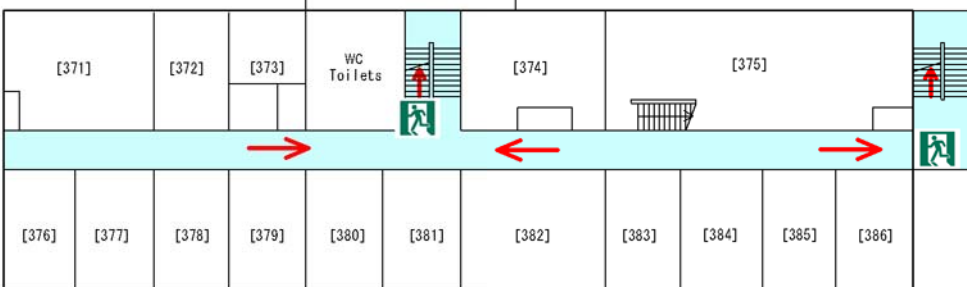
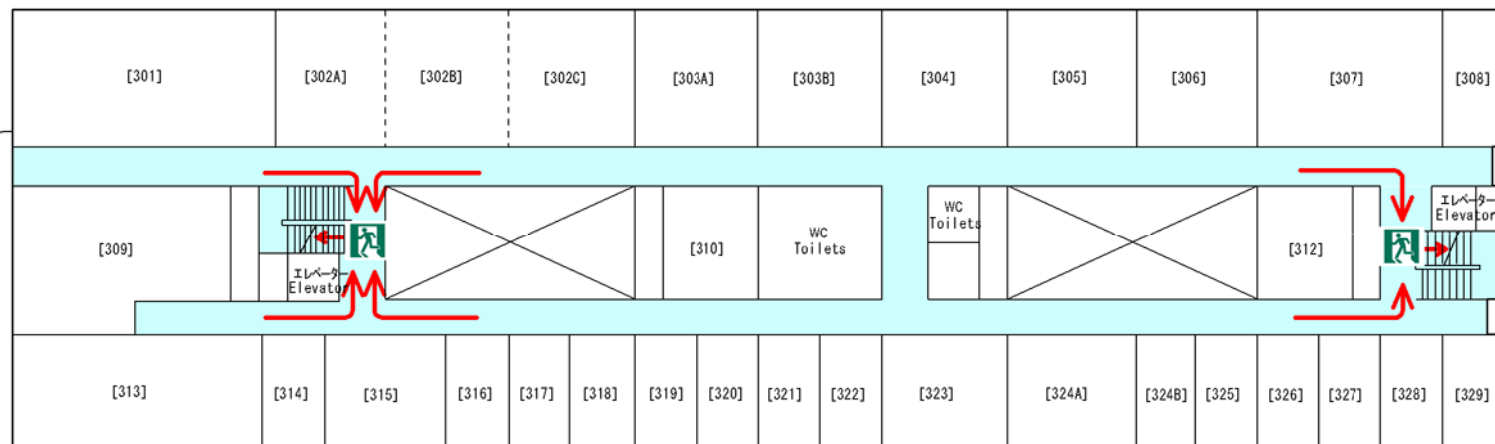

避難経路図
Evacuation Plan

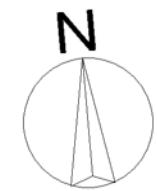
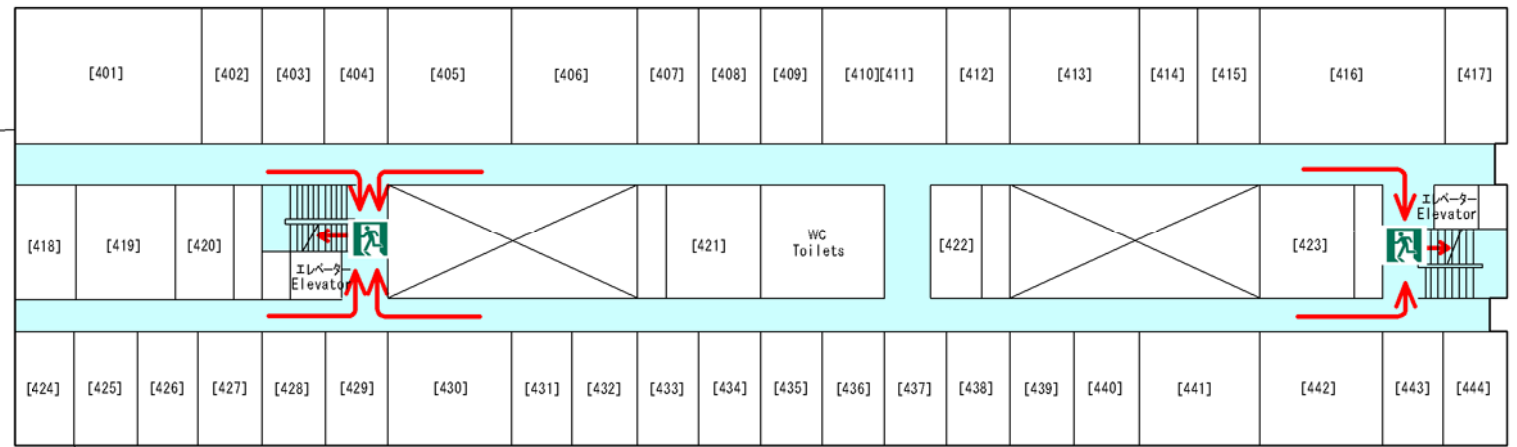

→ 避難経路
(Evacuation Route)

自然科学5号館 4階平面図
Layout of 4th Floor, Natural Science and Technology Hall 5

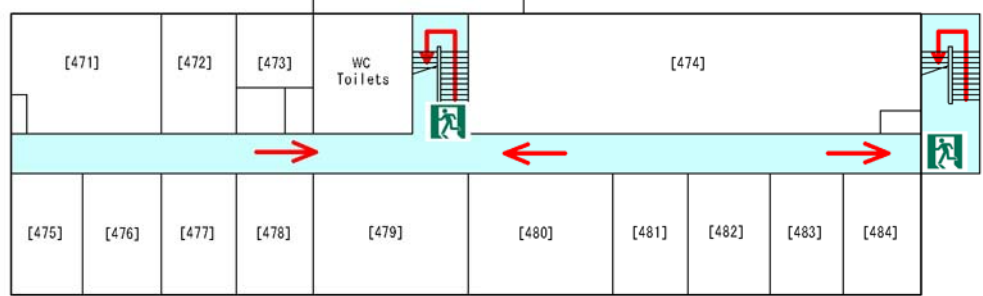

避難経路図 Evacuation Plan

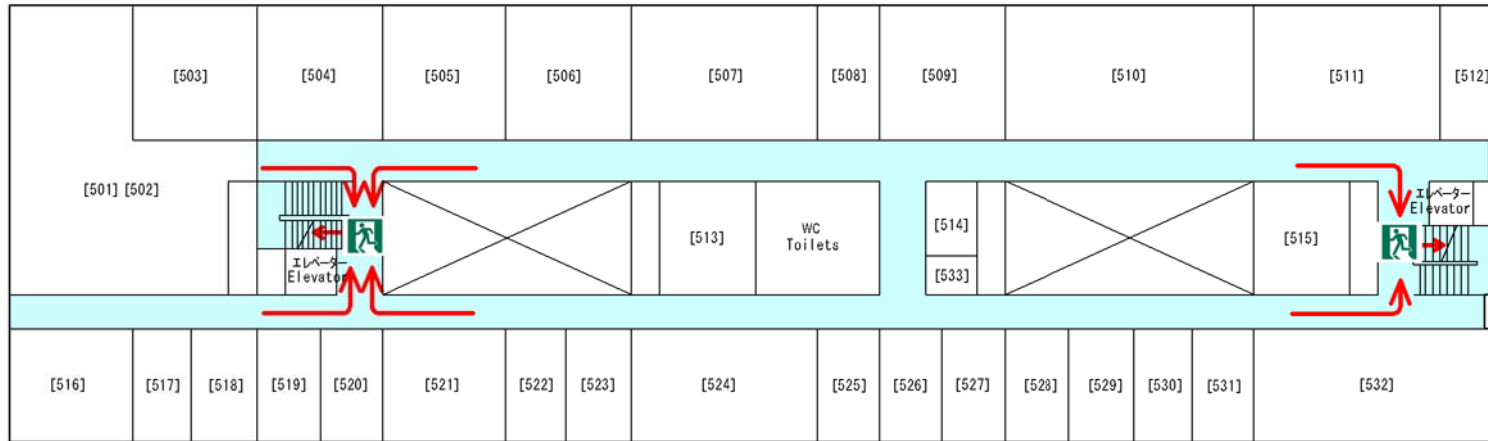
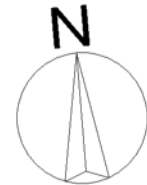

→ 避難経路
(Evacuation Route)

自然科学5号館 5階平面図

Layout of 5th Floor, Natural Science and Technology Hall 5

避難経路図 Evacuation Plan

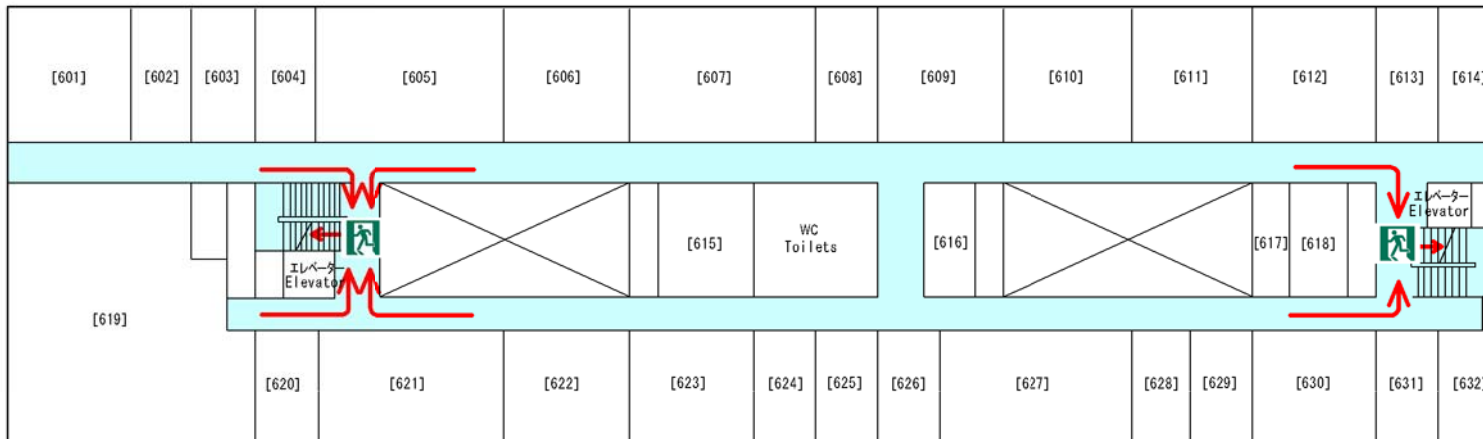
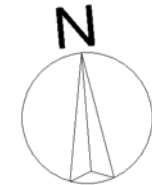

→ 避難経路
(Evacuation Route)

自然科学5号館 6階平面図

Layout of 6th Floor, Natural Science and Technology Hall 5

避難経路図 Evacuation Plan

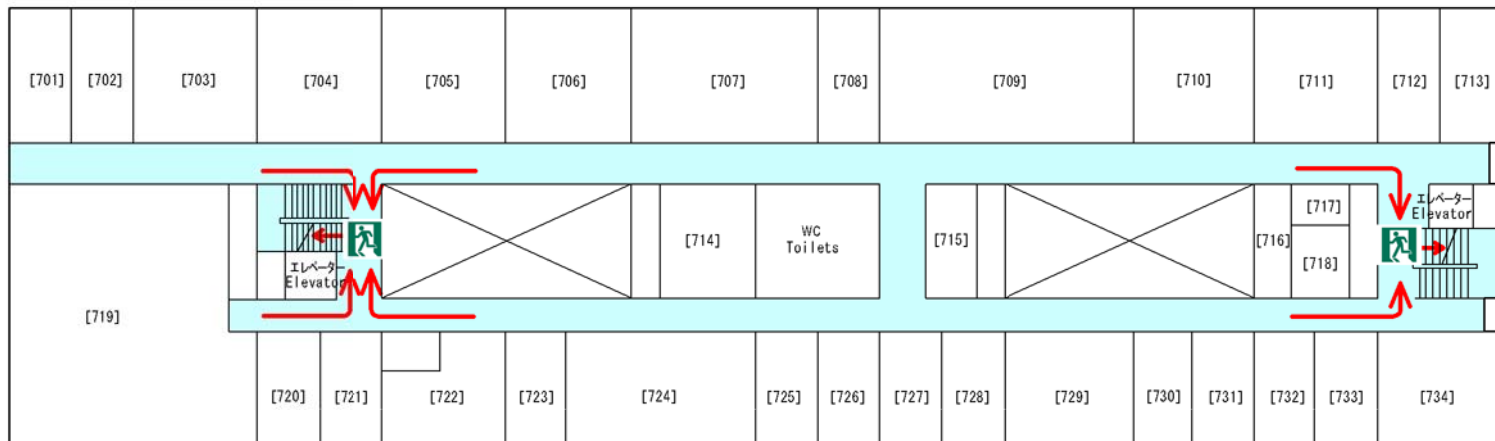
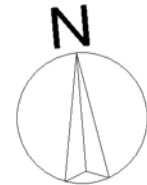

→ 避難経路
(Evacuation Route)

自然科学5号館 7階平面図

Layout of 7th Floor, Natural Science and Technology Hall 5

避難経路図 Evacuation Plan

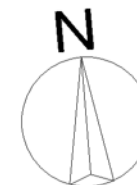
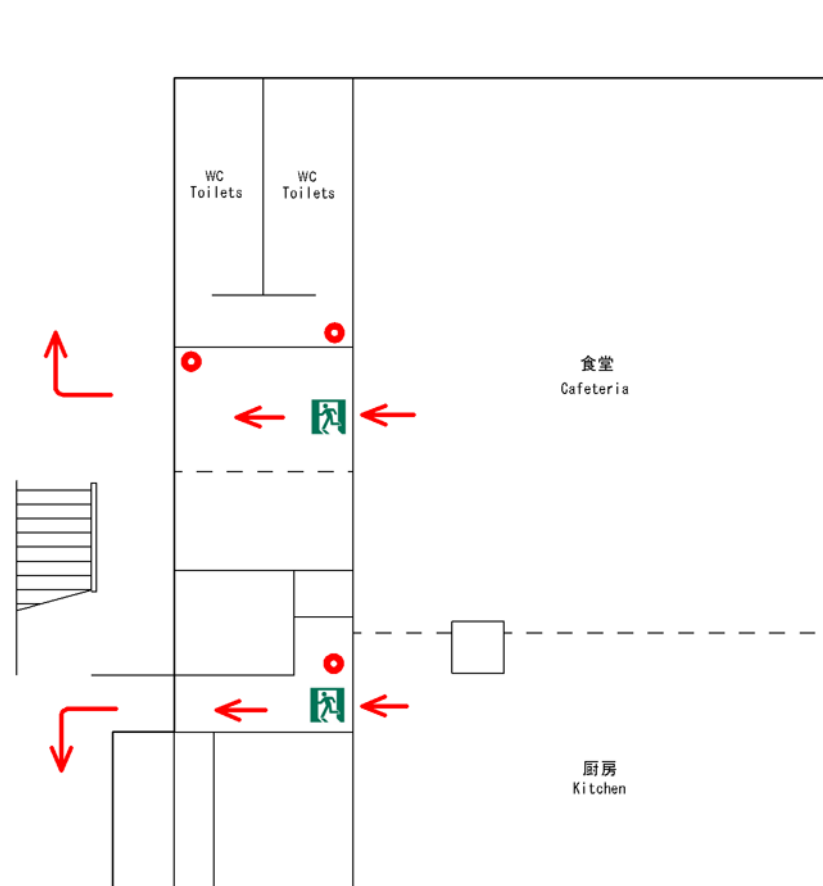

- 避難経路
(Evacuation Route)
- 消火器
(Fire Extinguisher)

中福利施設 1階平面図
Layout of 1st Floor, Central Campus Store and Restaurant

避難経路図
Evacuation Plan

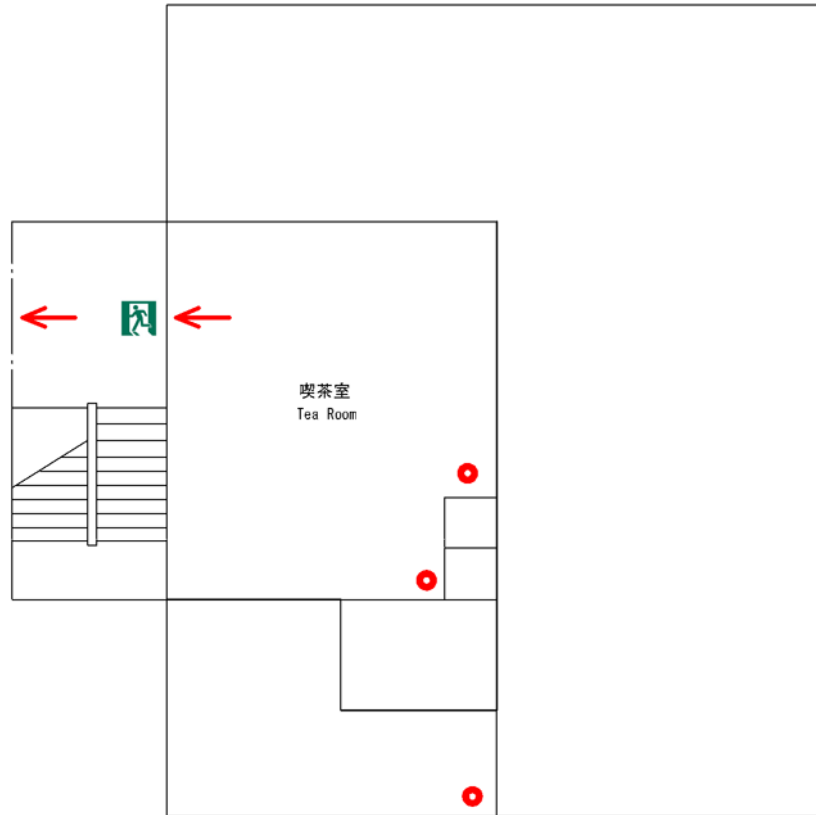

- 避難経路
(Evacuation Route)
- 消火器
(Fire Extinguisher)

中福利施設 2階平面図
Layout of 2nd Floor, Central Campus Store and Restaurant

避難経路図 Evacuation Plan

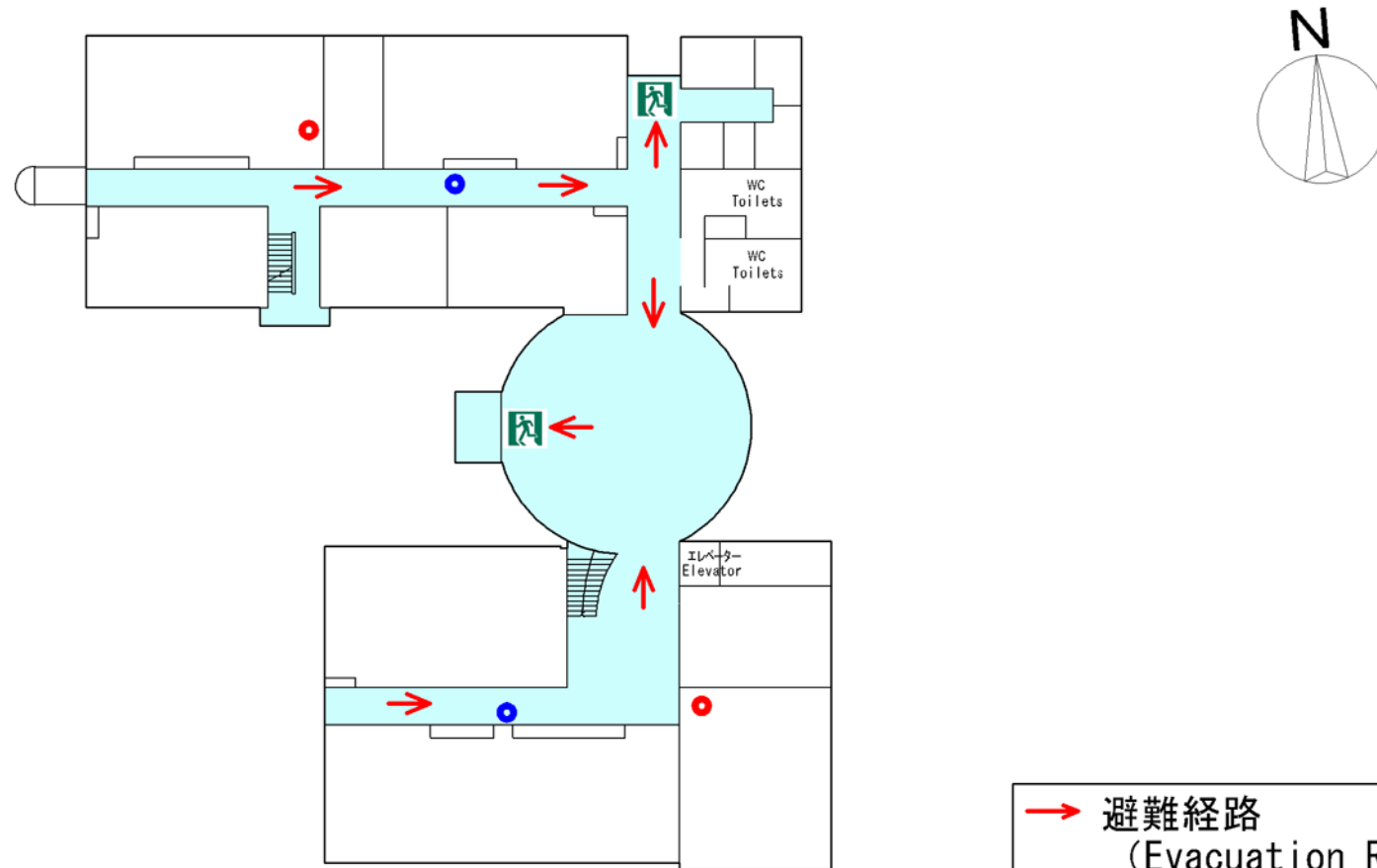

総合メディア基盤センター 1階平面図
Layout of 1st Floor, Information Media Center

- 避難経路
(Evacuation Route)
- 消火器
(Fire Extinguisher)
- 消火栓
(Fire Hydrant)

避難経路図
Evacuation Plan

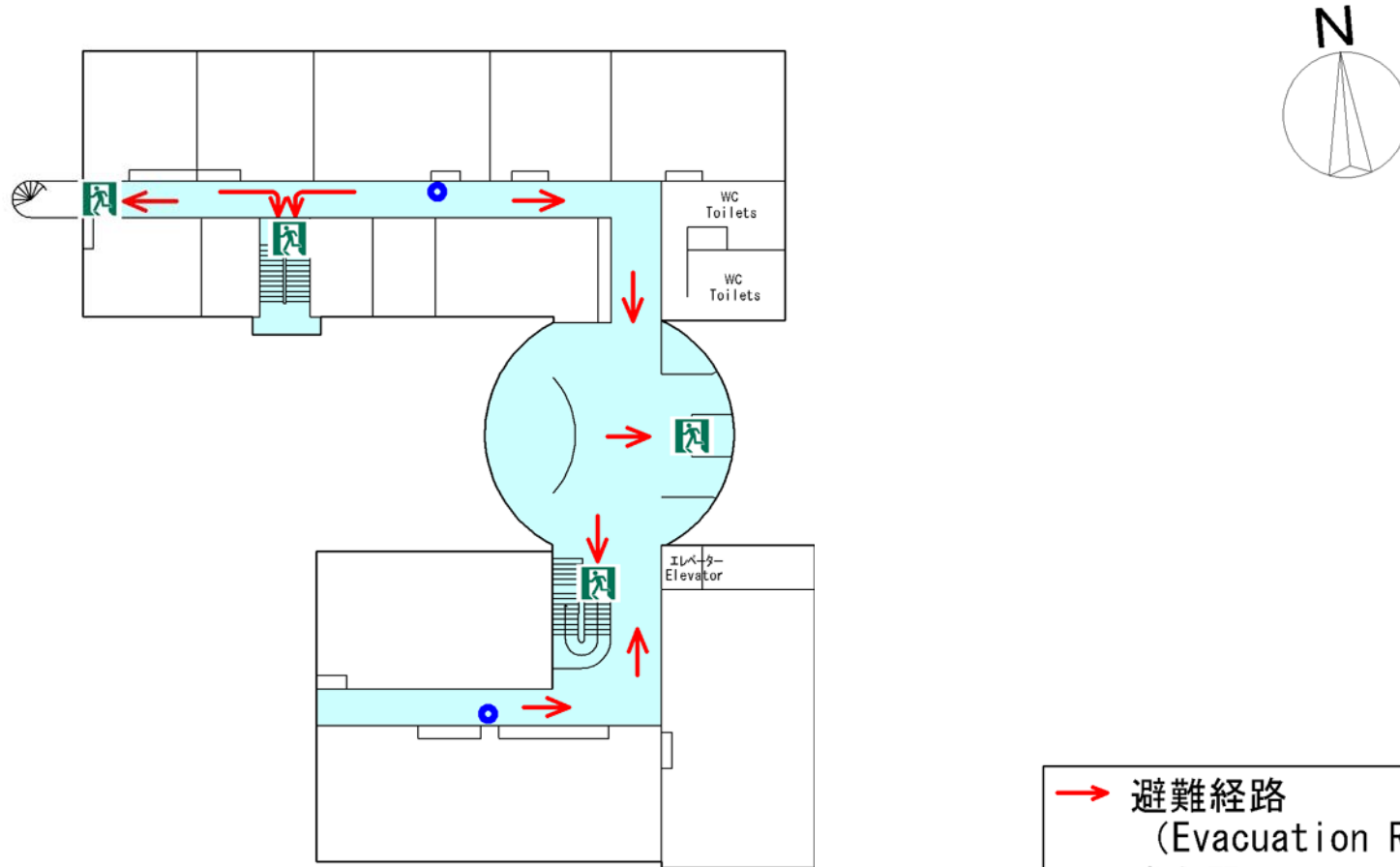

総合メディア基盤センター 2階平面図
Layout of 2nd Floor, Information Media Center

- 避難経路
(Evacuation Route)
- 消火器
(Fire Extinguisher)
- 消火栓
(Fire Hydrant)

避難経路図
Evacuation Plan

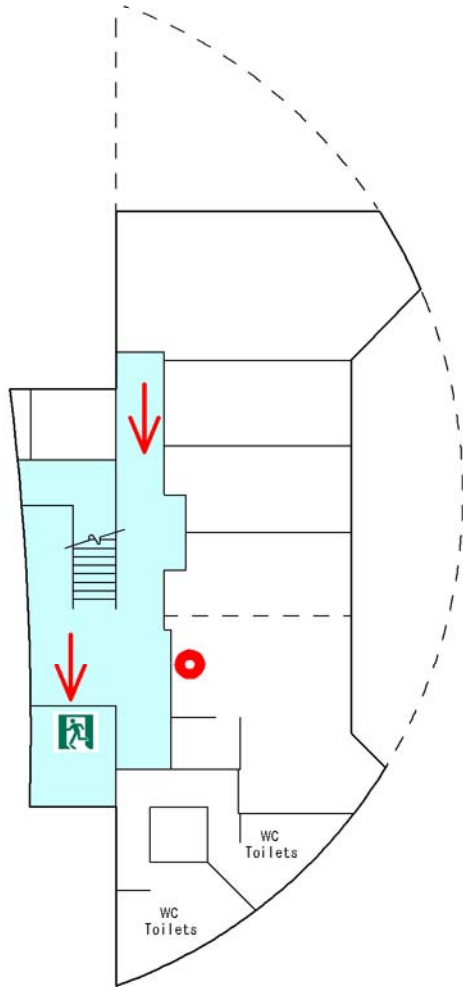

1階平面図
Layout of 1st Floor,
Center for Regional Collaboration

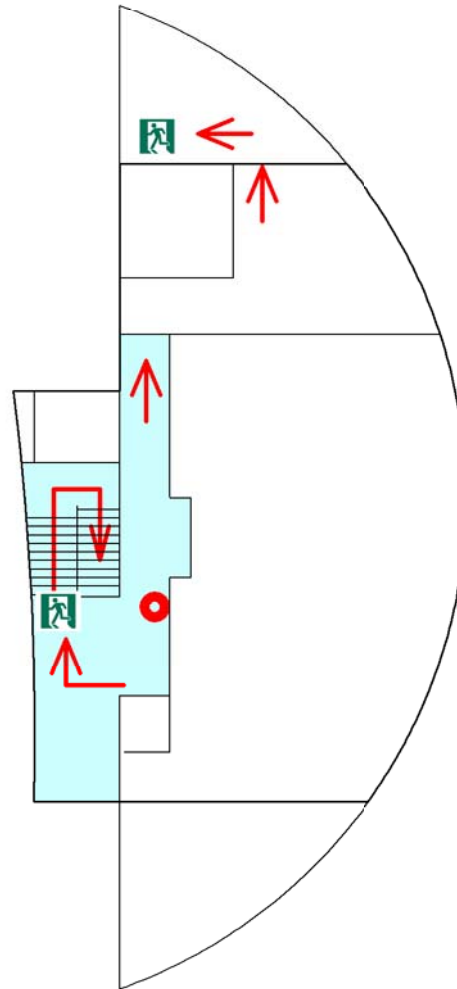

2階平面図
Layout of 2nd Floor,
Center for Regional Collaboration



- 避難経路
(Evacuation Route)
- 消火器
(Fire Extinguisher)

避難経路図
Evacuation Plan

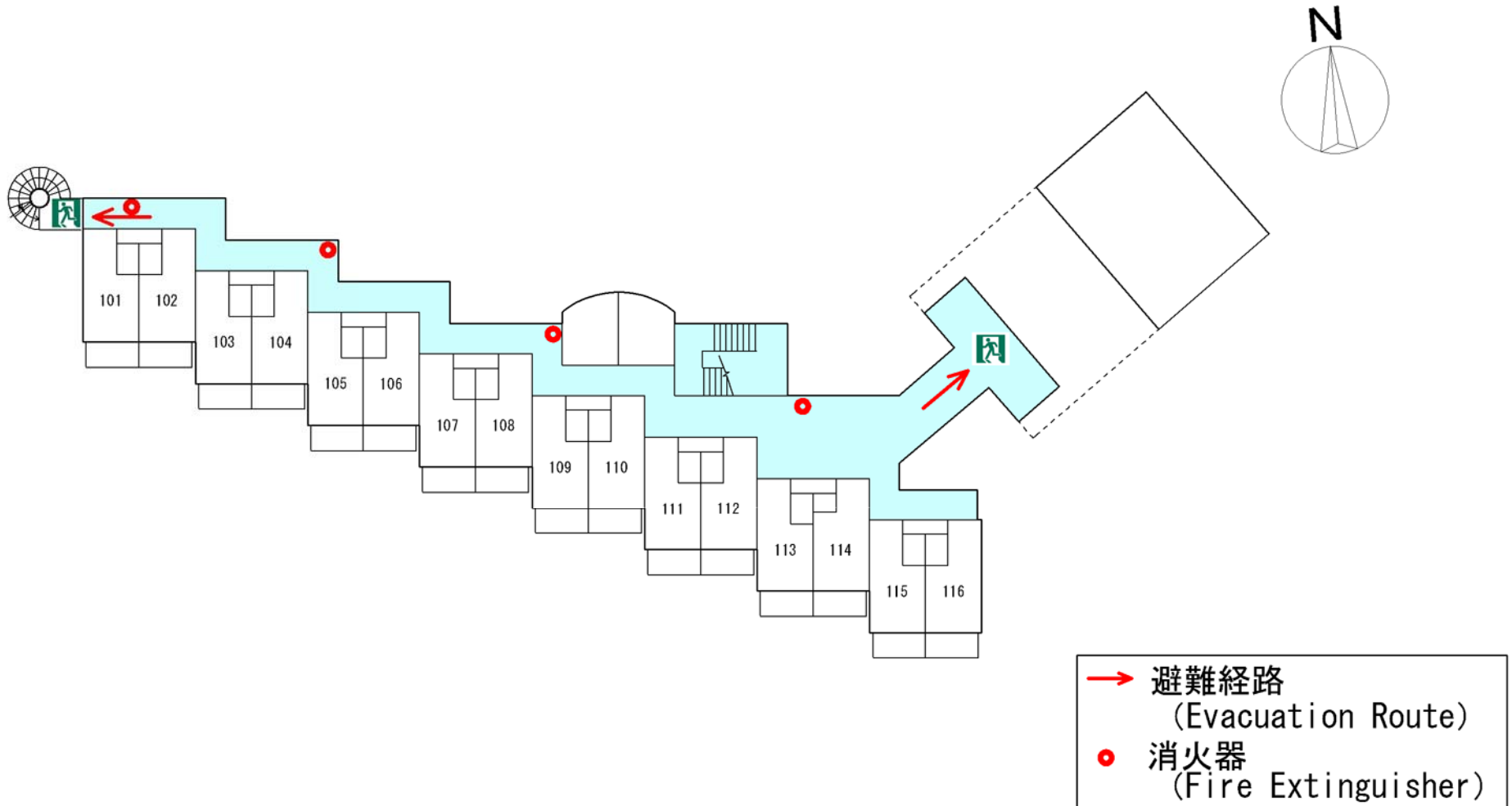

国際交流会館 1階平面図
Layout of 1st Floor, International House

避難経路図
Evacuation Plan

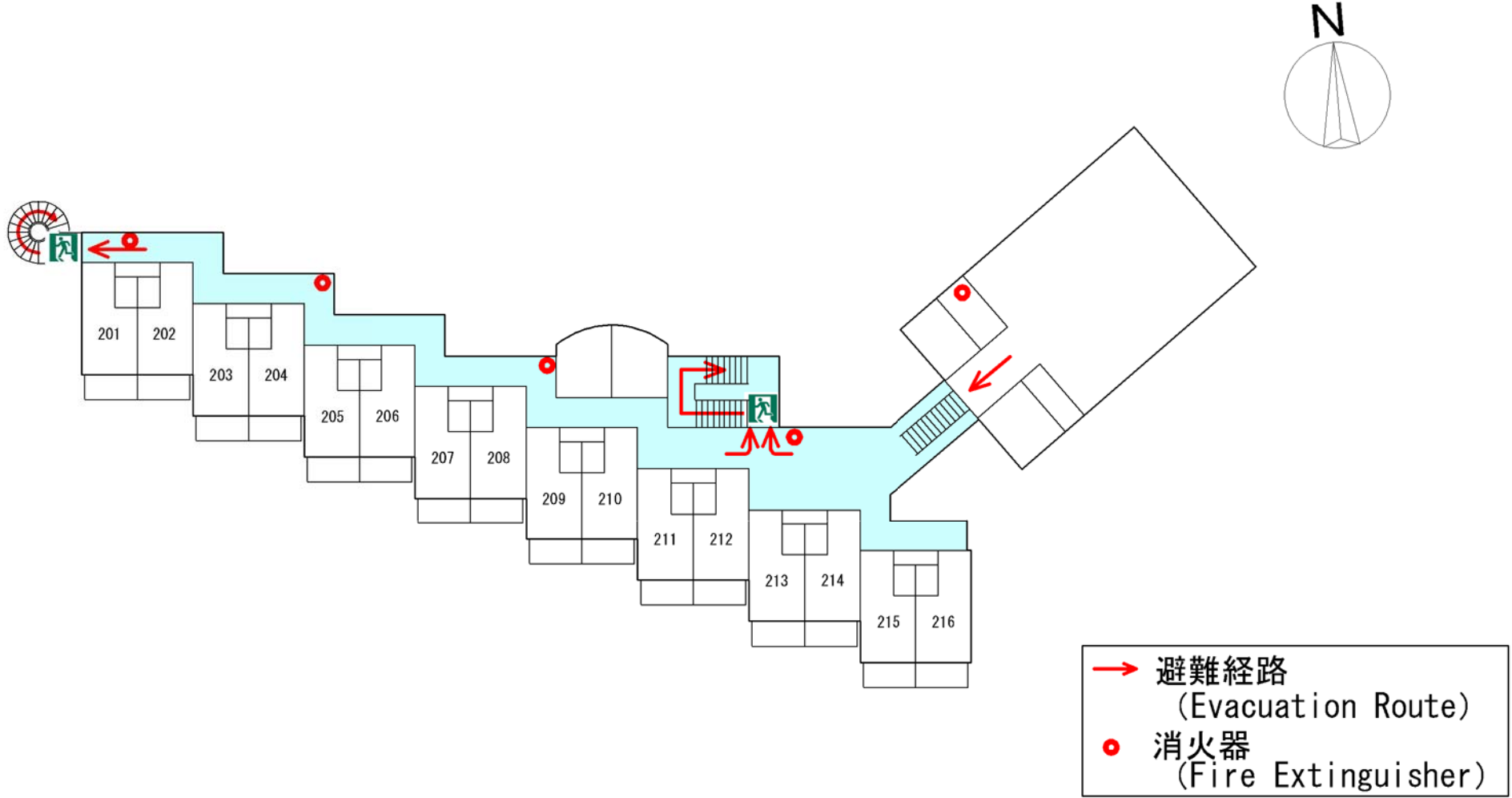

国際交流会館 2階平面図
Layout of 2nd Floor, International House

避難経路図
Evacuation Plan

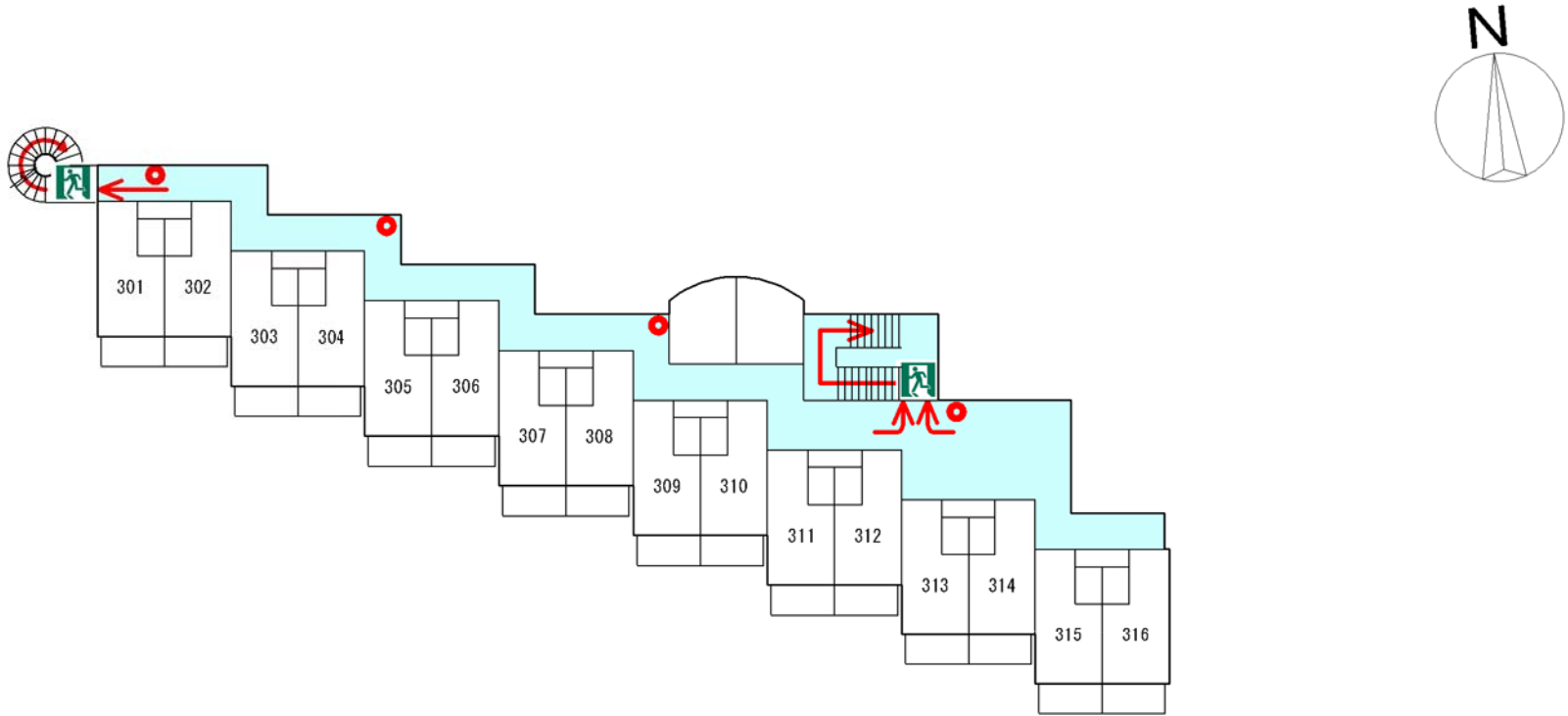

国際交流会館 3階平面図
Layout of 3rd Floor, International House

- 避難経路
(Evacuation Route)
- 消火器
(Fire Extinguisher)

避難経路図 Evacuation Plan

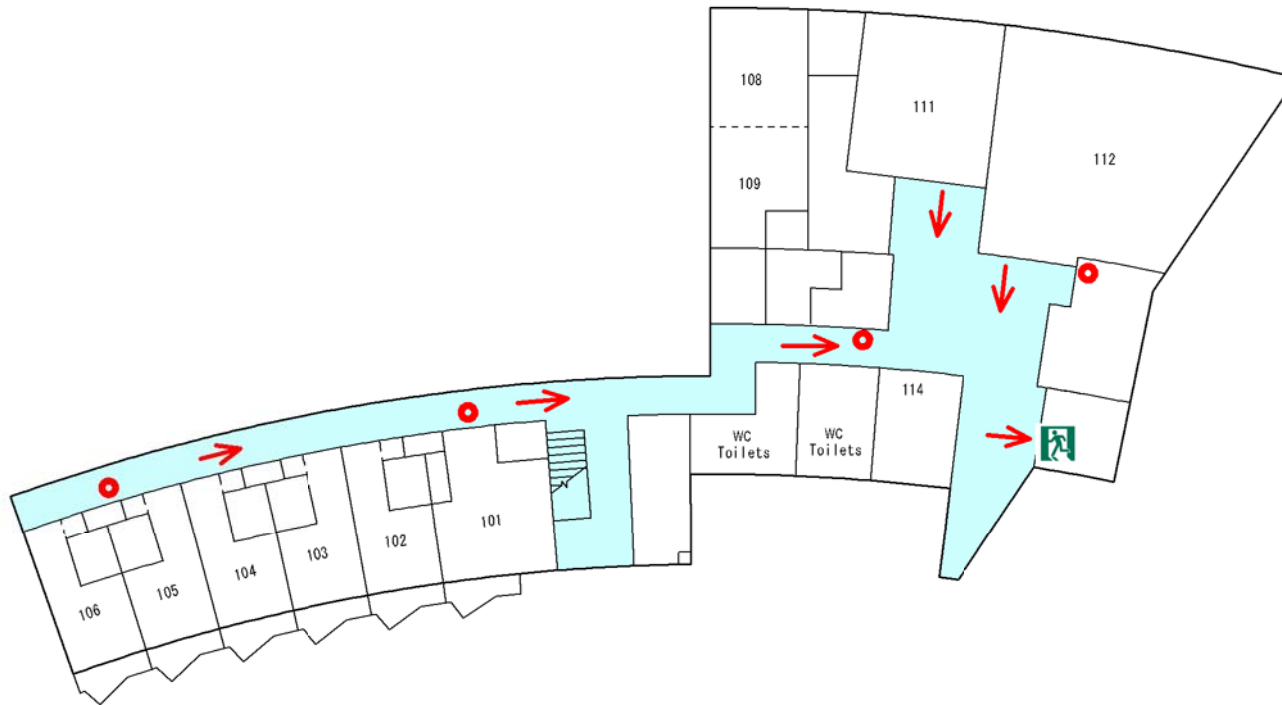
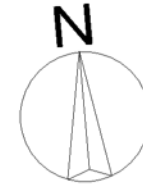

- 避難経路
(Evacuation Route)
- 消火器
(Fire Extinguisher)

角間ゲストハウス 1階平面図
Layout of 1st Floor, Guest House

避難経路図
Evacuation Plan

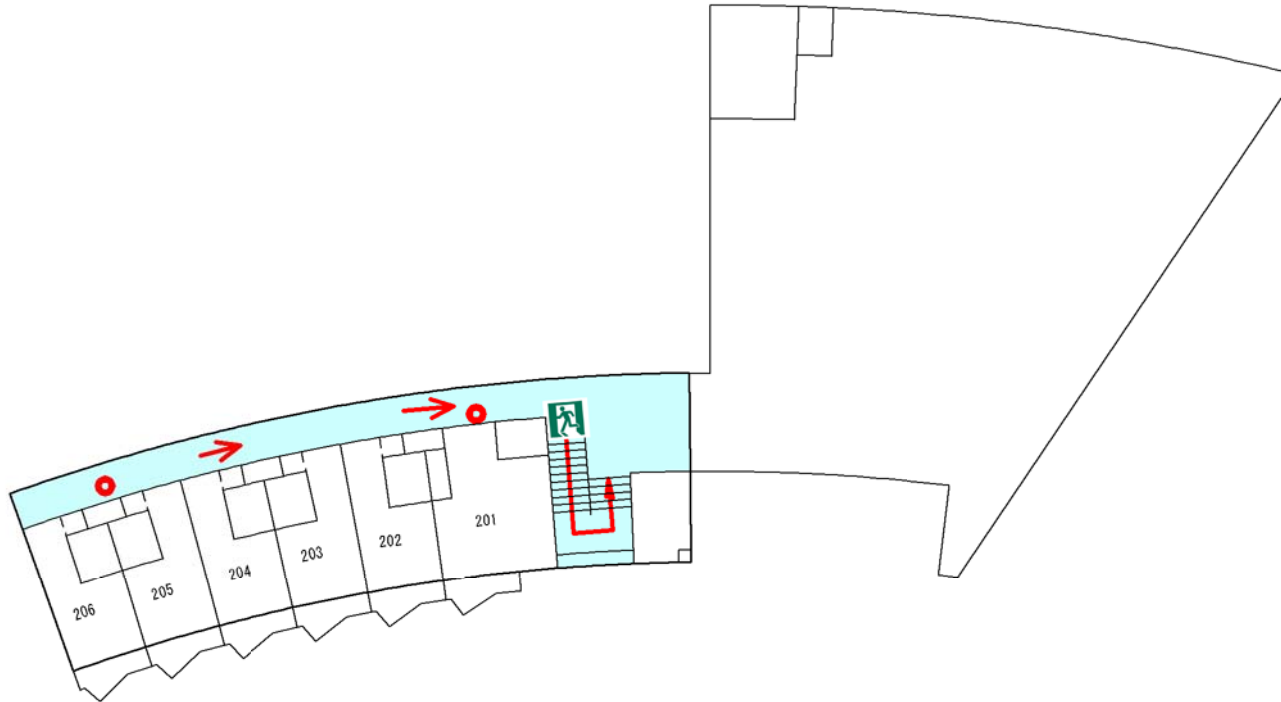

- 避難経路
(Evacuation Route)
- 消火器
(Fire Extinguisher)

角間ゲストハウス 2階平面図
Layout of 2nd Floor, Guest House

避難経路図
Evacuation Plan

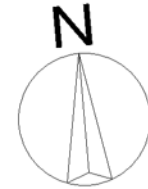
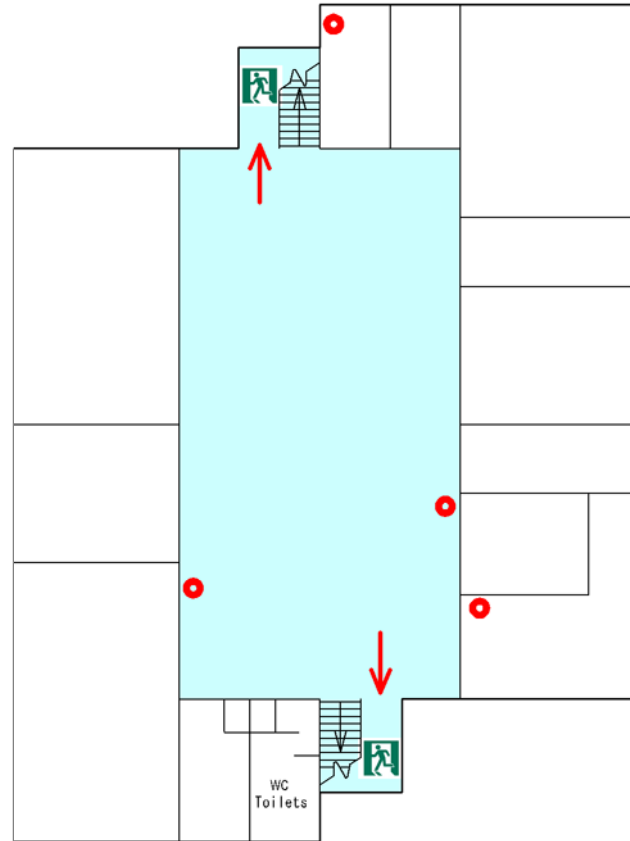

- 避難経路
(Evacuation Route)
- 消火器
(Fire Extinguisher)

東課外活動施設 1階平面図
Layout of 1st Floor, East Clubhouse

避難経路図
Evacuation Plan

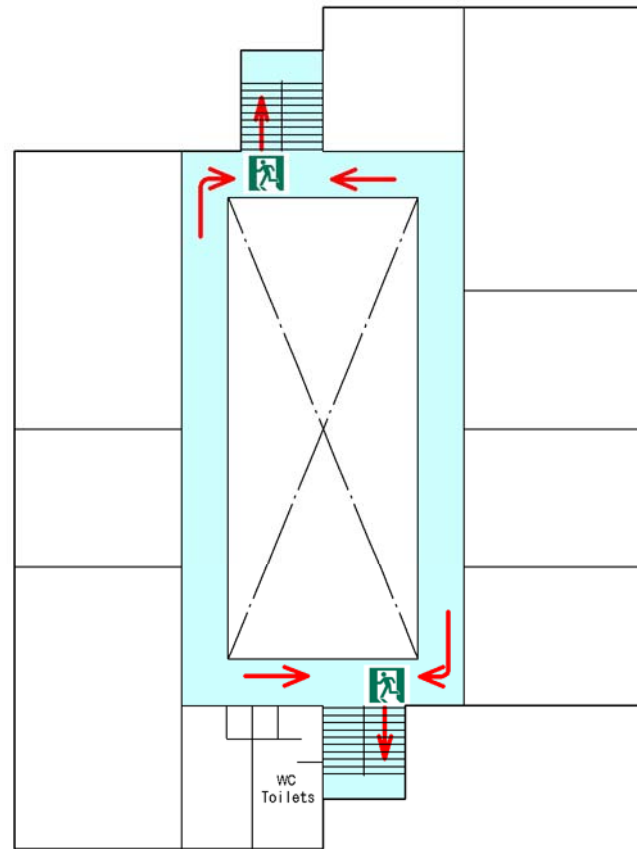

- 避難経路
(Evacuation Route)
- 消火器
(Fire Extinguisher)

東課外活動施設 2階平面図
Layout of 2nd Floor, East Clubhouse

避難経路図
Evacuation Plan

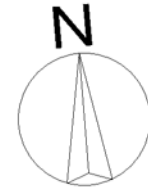
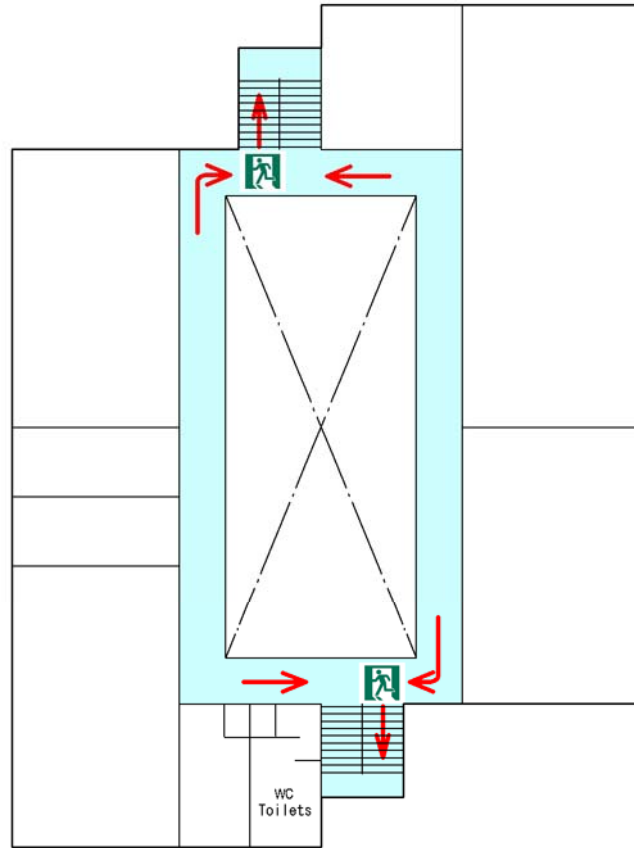

- 避難経路
(Evacuation Route)
- 消火器
(Fire Extinguisher)

東課外活動施設 3階平面図
Layout of 3rd Floor, East Clubhouse

避難経路図 Evacuation Plan

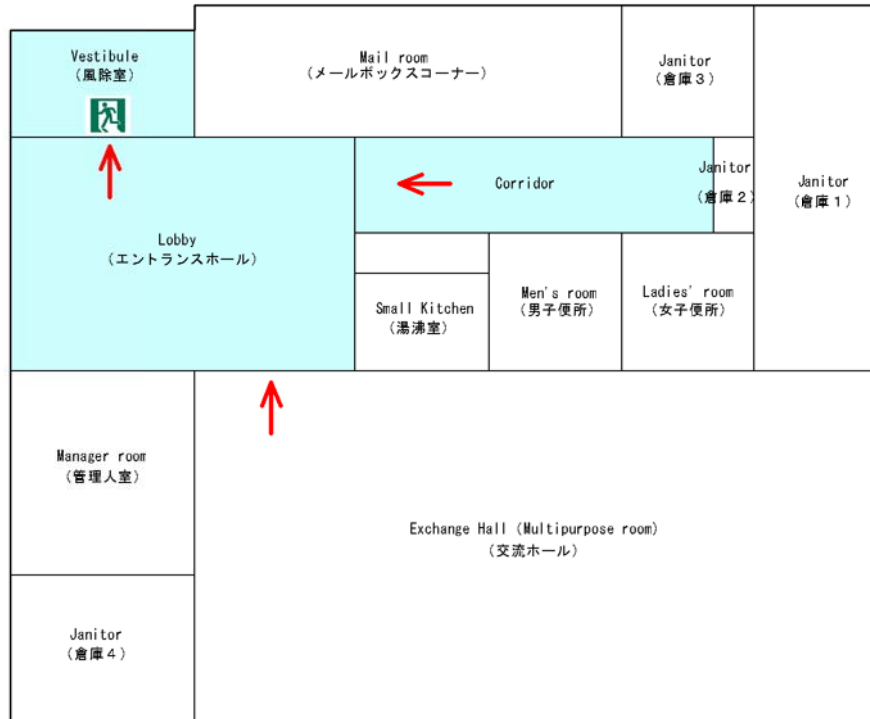

- 避難経路
(Evacuation Route)
- 消火器
(Fire Extinguisher)

国際交流棟 1階平面図
Layout of 1st Floor, Exchange Hall

避難経路図 Evacuation Plan

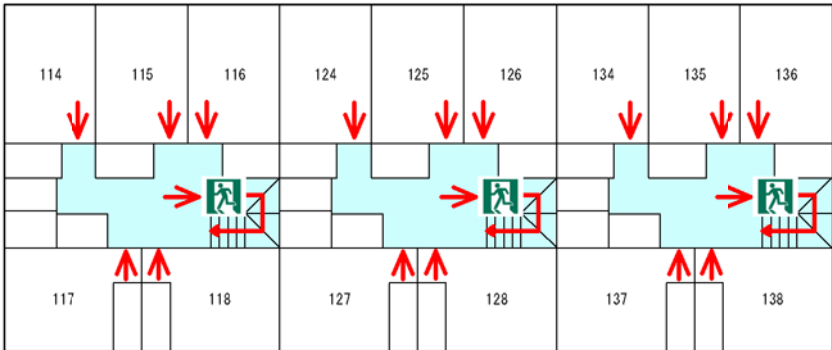

Layout of 2nd Floor, Building 1

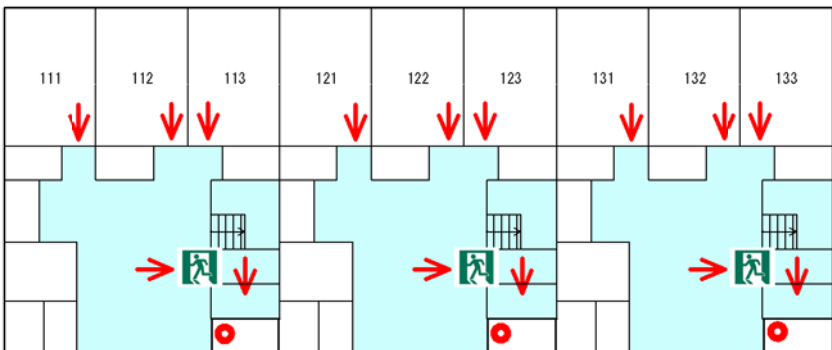

Layout of 1st Floor, Building 1

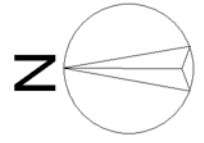

- 避難経路
(Evacuation Route)
- 消火器
(Fire Extinguisher)

先魁1号棟 平面図
Building 1

避難経路図 Evacuation Plan

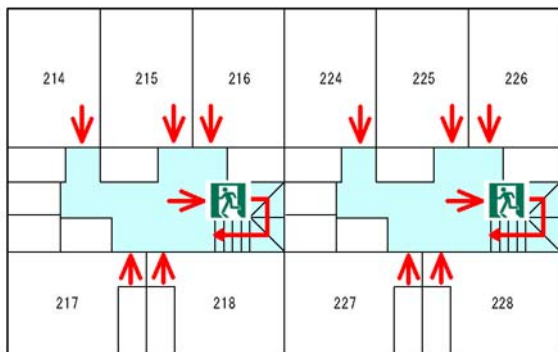

Layout of 2nd Floor, Building 2

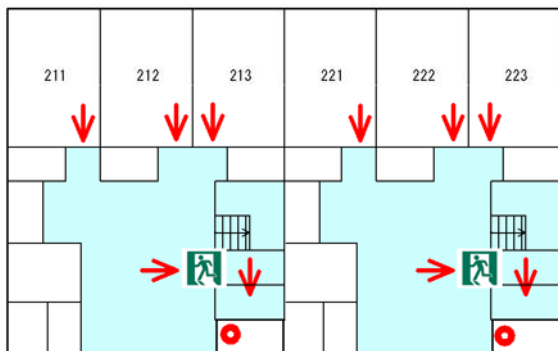

Layout of 1st Floor, Building 2



- 避難経路
(Evacuation Route)
- 消火器
(Fire Extinguisher)

先魁2号棟 平面図
Building 2

避難経路図 Evacuation Plan

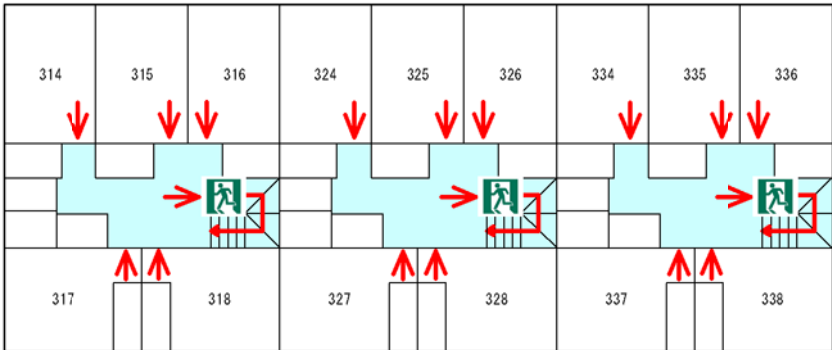

Layout of 2nd Floor, Building 3

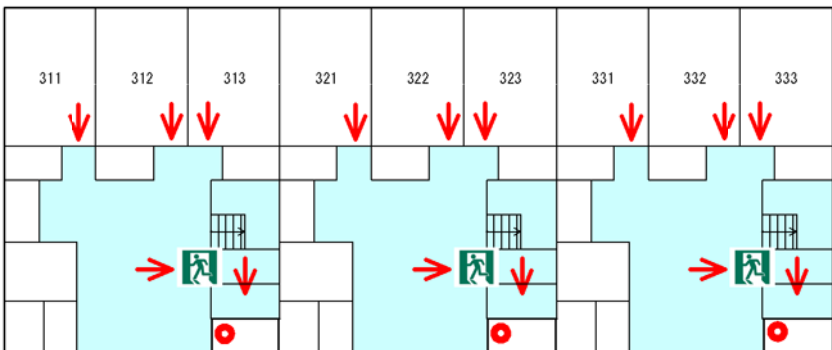

Layout of 1st Floor, Building 3

- 避難経路
(Evacuation Route)
- 消火器
(Fire Extinguisher)

先魁3号棟 平面図
Building 3

避難経路図 Evacuation Plan

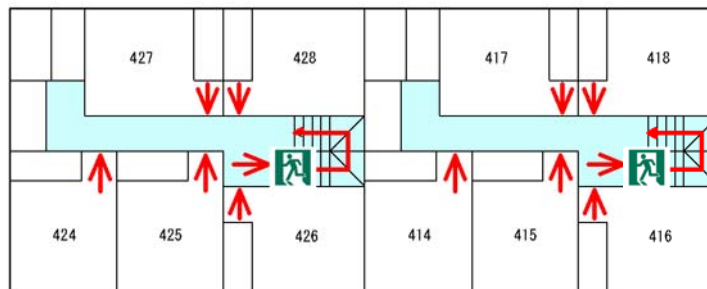

Layout of 2nd Floor, Building 4

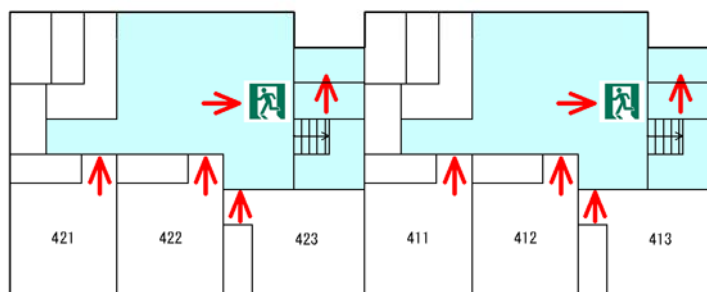

Layout of 1st Floor, Building 4



先魁4号棟 平面図
Building 4

避難経路図 Evacuation Plan

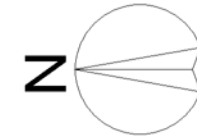
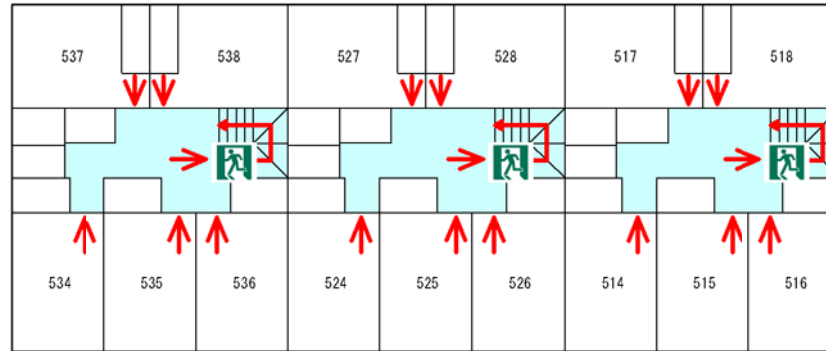

Layout of 2nd Floor, Building 5

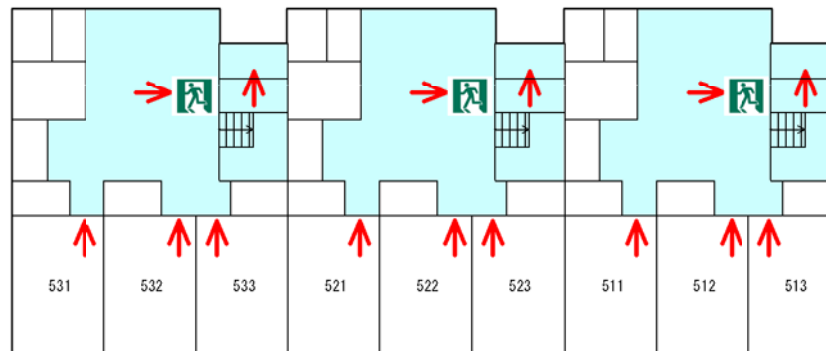

Layout of 1st Floor, Building 5



先魁5号棟 平面図
Building 5